

PLATE TRANS.

115V. @ 60W
to

1500/1750/2,000/2250/2500V. @ 460MA.

No-Lens → 1590/1856/2120/2385/2650

LINDQUIST

SPEC. NO. 1900

Winding		SEC.		PRI.			
Turns		3260		236			
Taps		—		142-157-177-202			
Wind. Lgth.		2½"		2½"			
Wire Size		#27		#14			
T. P. L.		142-23L		34-7L			
Finish		86½%		89½%			
Type Lead		SIL. BR. VINYL. SOLY.		W.O.			
Lead Lgth.		3"		3"			
Layer Insul.		2-L 30-66.6		1-L .010" CP			
Test Volt.		6,000V.		1500V.			
Wrapper		2-L .007" VC 2-L .007" GA		2-L .007" GA			

TUBE 10-2.007" GK + 1-L .005" VC IMPREGNATION DOUBLE VARNISH

CORE 1 3/4" x 3 1/4" E+I GA. 24 GRADE D STACK 2x2

MOUNTING CC

Cu = 840-704
Fe = 611 @ 60W
TPV = 1.23-1.365-1.54-1.785-2.05
WN = 974 (.941)

Sec. VA = 500,
PRI. VA = 670
PRI. I = 5.83

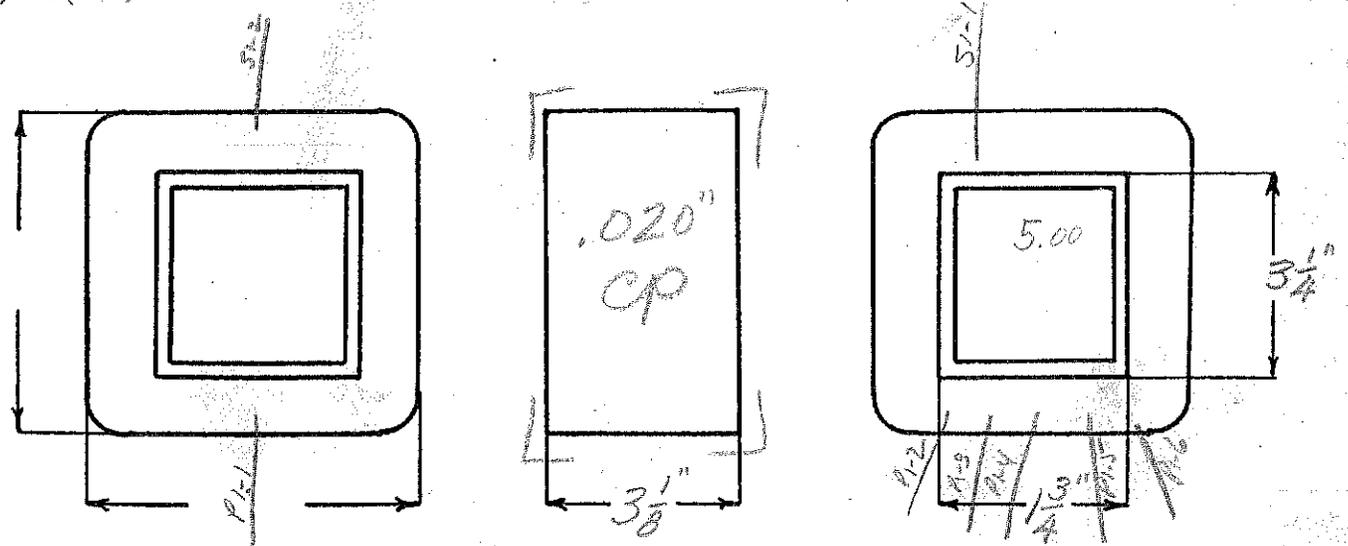

DESIGNED BY *H.H.H.*

DATE MAR 5 1945

1900

PRI
115V @ 60Hz

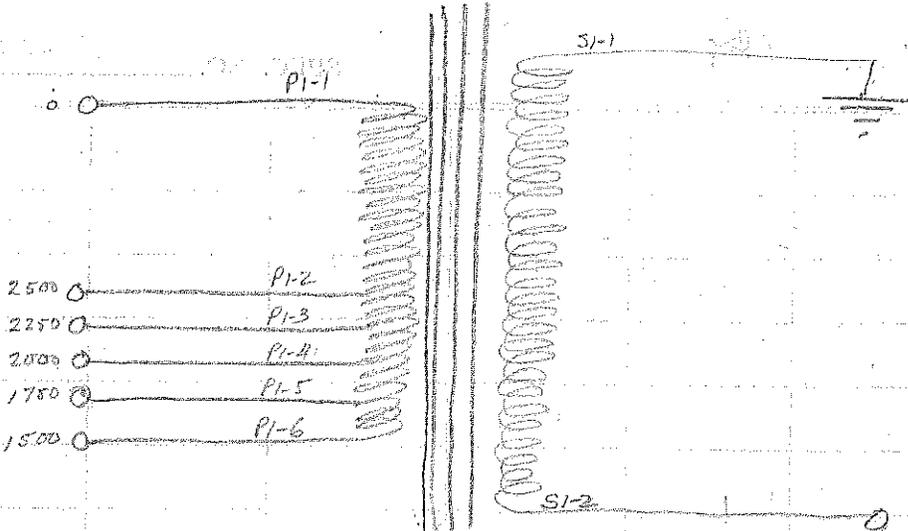

SEC
1500/1750/2000/2250/2500V
@ 400MA

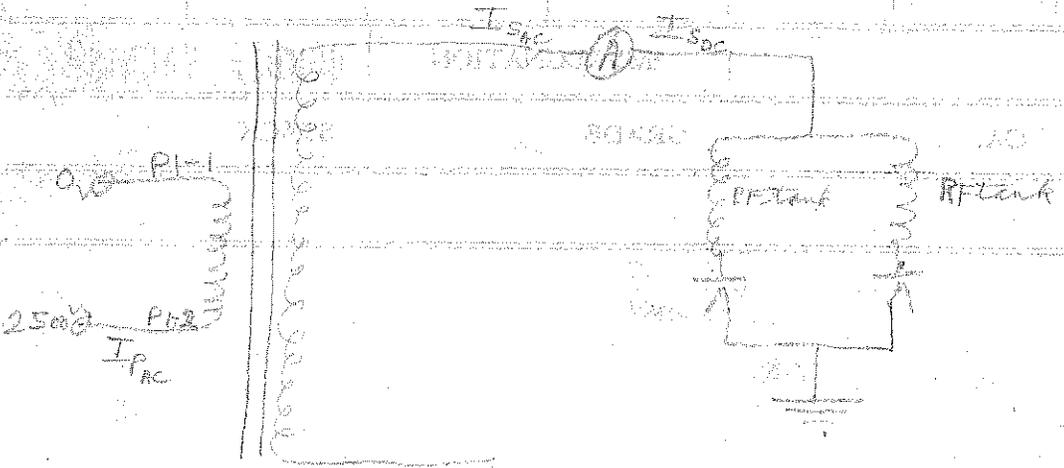

I_{sdc}
150ma
200
100
50

I_{Pri}
8.02a
10.3
5.9
3.6

I_{sdc}
169ma
216
121
67

Push pull triode plates to push pull grids.
3 to 1 overall ratio

OLD

SPEC. NO. 11001

Winding	PRI	SEC				
Turns	2200	5700				
Taps	—	—				
Wind. Lgth.	7/16	7/16				
Wire Size	40	40				
T.P.L.	113-20	113-56				
Kind Term.	Sil. Braid					
Term. Lgth.	3	3				
Layer Insul.	12#	12#				
Test Volt.						
Wrapper	2L003VP	2L005 ^K GA				

TUBE	7L007	IMPREGNATION	WAX
CORE	7/8 x 7/8 2 x 2 29GA Grade B	PRIMARY V.A.	
MOUNTING	D		

Wire Net = 0.304" (0.304")

Connect Leads inside of Coil

OVER

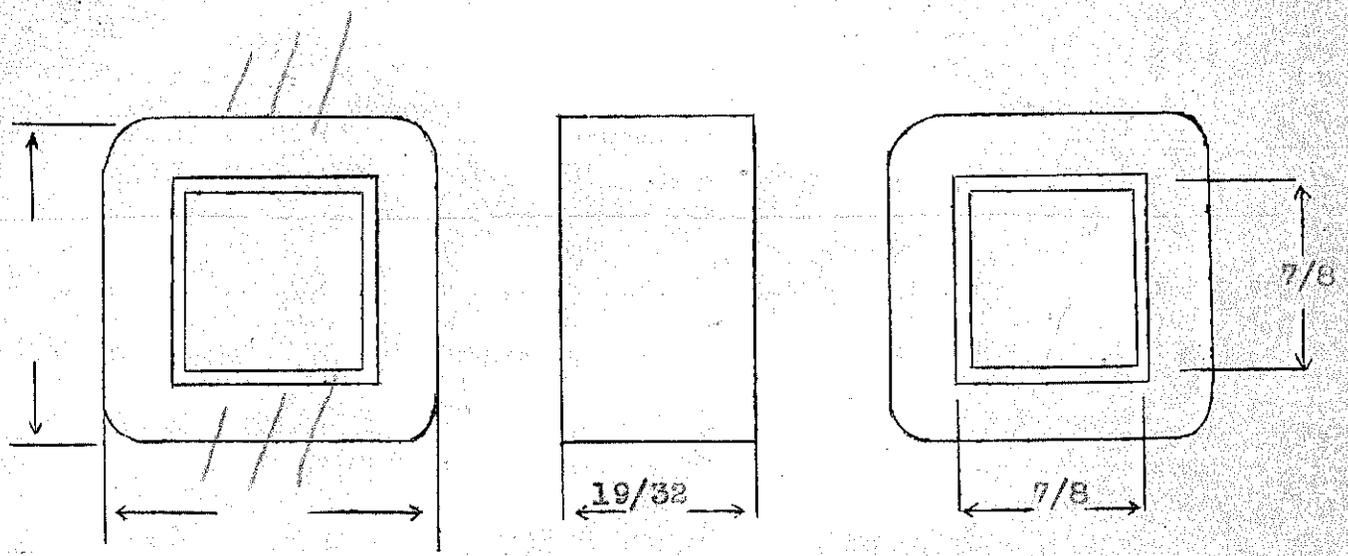

DESIGNED BY C.W.

DATE

2

10510

S

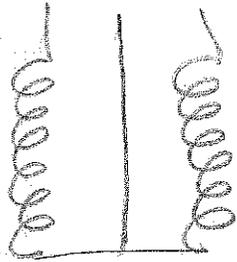

Reverse Assembly

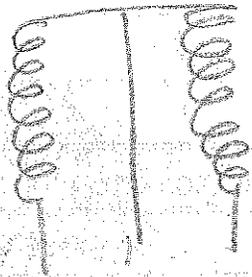

P

Push pull triode plates to push pull grids. Ratio 1 to 1.
Especially suitable for "A" prime inputs.

OLD

SPEC. NO. D1902

Winding	SEC	PRI				
Turns	3400	3400				
Taps						
Wind. Lgth.	7/16	7/16				
Wire Size	39	39				
T. P. L.	100-34	100-34				
Finish						
Type Lead	Sil Braid					
Lead Lgth.	3	3				
Layer Insul.	12#	12#				
Test Volt.						
Wrapper	2L003VP	2L005GA				

TUBE	7L007	IMPREGNATION	WAX
------	-------	--------------	-----

CORE	7/8 x 7/8 2 x 2 GA. 29	GRADE B	STACK 2x2
------	------------------------	---------	-----------

MOUNTING

Connect leads inside coil-

over

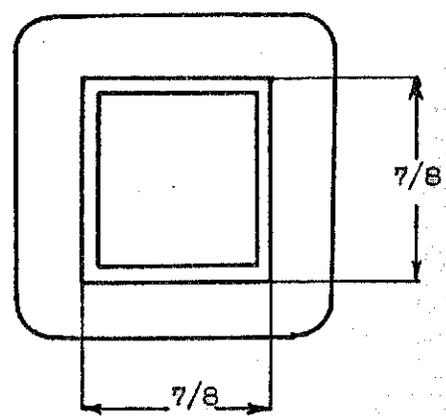
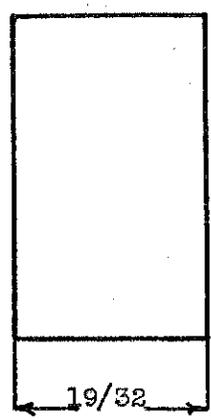
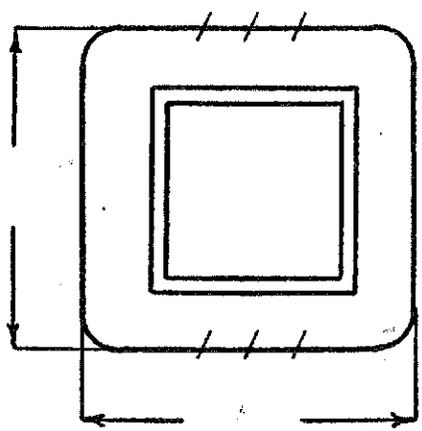

DESIGNED BY

OVER

DATE

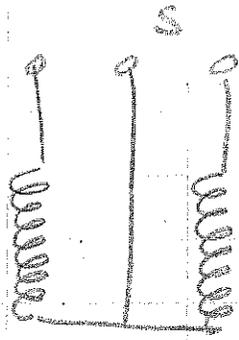

Reverse Assembly

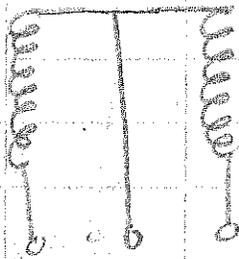

FLAT BOARD

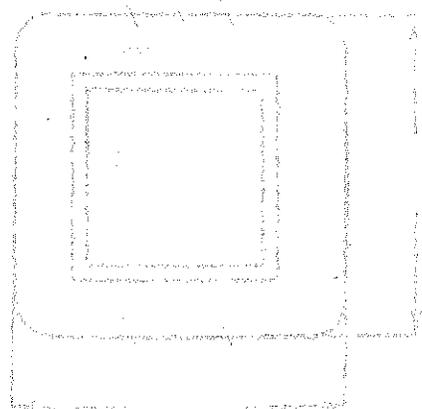
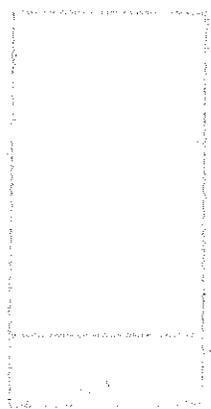
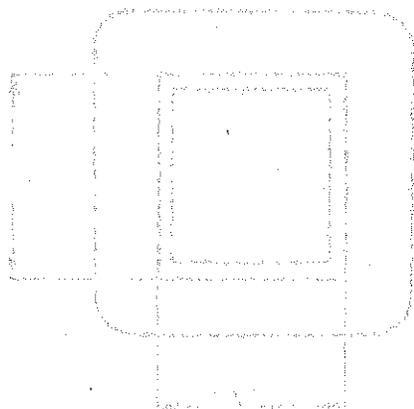

From 50-125-200-300 ohm lines or microphones to single or push pull grids

OLD

125, 200 to 200
(400)

SPEC. NO. B1903

Winding	Sec.	Pri.				
Turns	12,000	800 480				
Taps	6000	400 240				
Wind. Lgth.	1-1/16	1-1/16				
Wire Size	#40	#29				
T.P.L.	274-44	80-10				
Kind Term.	Sil Braid					
Term. Lgth.	3"	3"				
Layer Insul.	12#	30#				
Test Volt.	2000 1250	2000 1250				
Wrapper	1L007VC	2L005GA				

TUBE	7L007	IMPREGNATION	VARNISH
CORE	7/8 x 7/8 29 ga.	2 x 2	PRIMARY V.A.
MOUNTING	D - Lugs		

Wire Net = 0.307 (0.313")

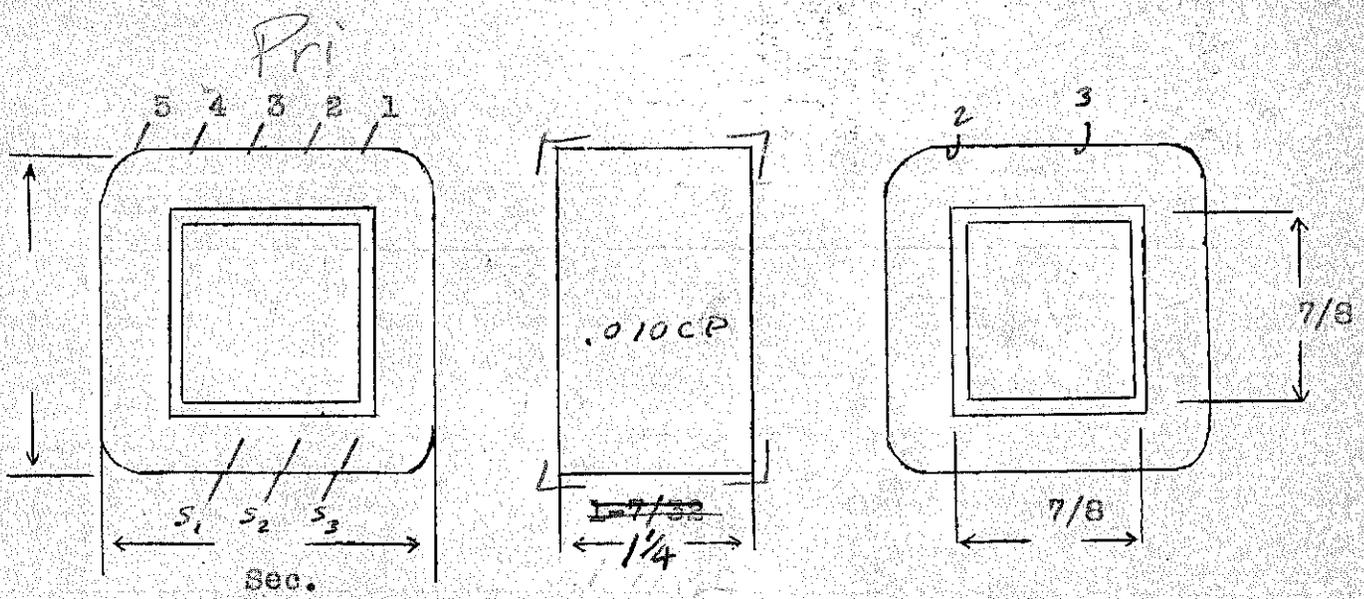

DESIGNED BY G.S.

DATE

From 50-125-200-500 ohm lines to 50, 125,
200 or 500 ohm line. Can be used to
match lines or microphones to lines.

7559

SPEC. NO. D1904

Winding	P	S				
Turns	800	800				
Taps	480	480				
	400	400				
	240	240				
Wind. Lgth.	-1-1/16-					
Wire Size	#29	#29				
T.P.L.	80-10	80-10				
Kind Term.	Sil. Braid					
Term. Lgth.	3	3				
Layer Insul.	40#	40#				
Test Volt.						
Wrapper	1L007VC	2L005GA				

TUBE	7L007	IMPREGNATION	VARNISH
CORE	7/8 x 7/8	2 x 2	29Ga
MOUNTING	D	PRIMARY V.A.	

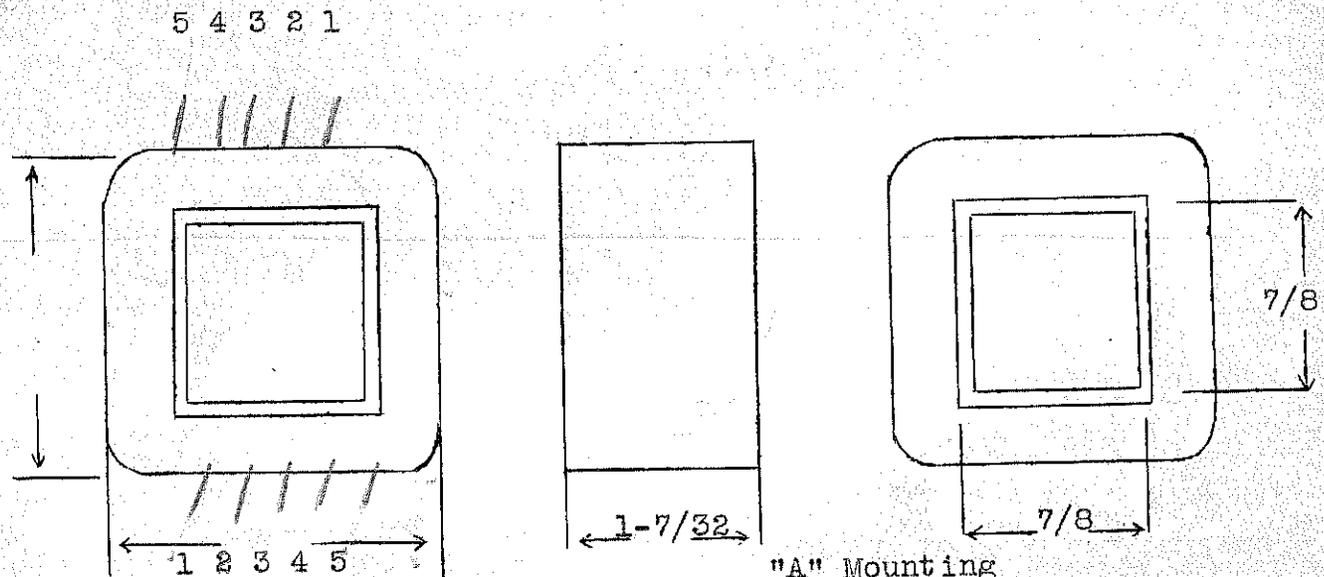

"A" Mounting
Starts- Black
50 - Red
125 - Blue
200 - White
500 -

DESIGNED BY G.W.

DATE

SPEC. NO. D 1905

Winding	Continuous PRI	Continuous SEC				
Turns	4000	42	48	42		
Taps	2000	-	35 22			
Wind. Lgth.	1-1/16					
Wire Size	#36	#20	22	24		
T. P. L.	170-24					
Finish						
Type Lead	Sil. Br.	WIRE ONLY				
Lead Lgth.	3"	3"	3"	3"		
Layer Insul.	30#		50#			
Test Volt.						
Wrapper	2L.005GA			2L.005GA		
TUBE	7L.007		IMPREGNATION		VARNISH	
CORE	7/8 x 7/8	GA.	GRADE		STACK 2 x 2	
MOUNTING						

Start - 20 - Wire

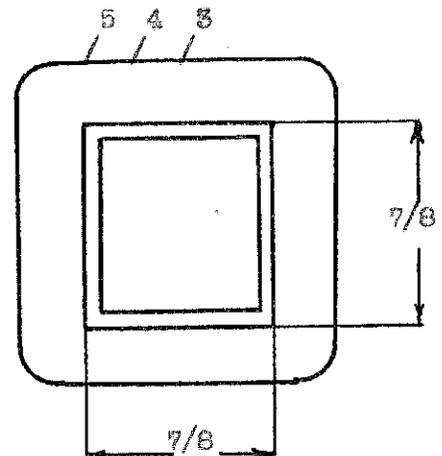
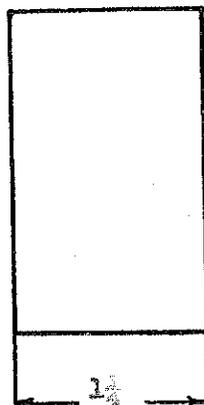
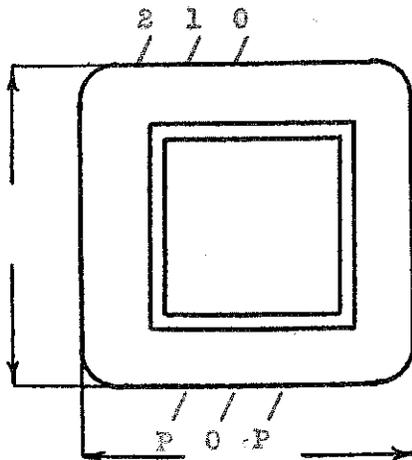

DESIGNED BY

DATE

1.75 - 1.335
5.5 - 1.87
5.0 - 2.25
7.5 - 2.65
1.5 - 3.87
14,000 - 118.5

REVISIONS

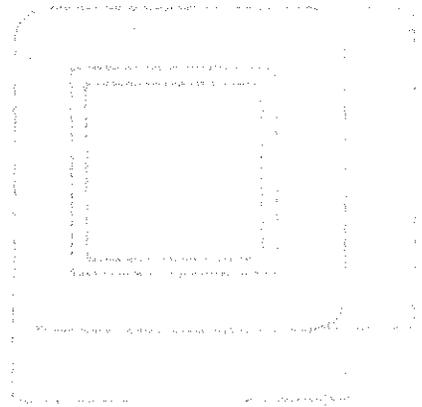
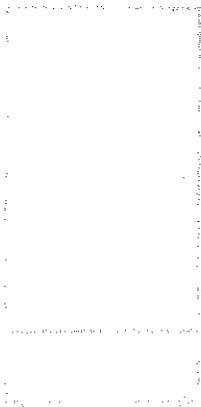
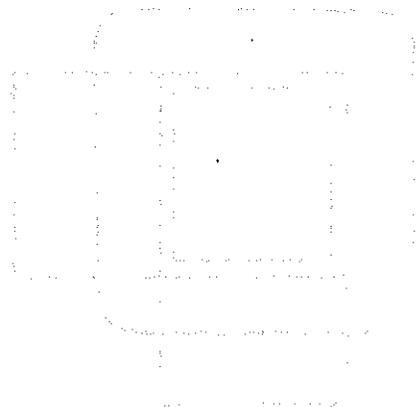

PP 2A5, 42, or Class B 19, 53, 6A6 etc to 300 ^{or}

A. E. RAVENSCROFT 500 ^{or} line

SPEC. NO. 1906

Winding	PRI	SEC				
Turns	4000	760				
Taps	2000	480				
Wind. Lgth.	1 1/2	1 1/2				
Wire Size	# 36	# 29				
T.P.L.	170-24	80-10				
Kind Term.	sil Bind					
Term. Lgth.	3"	3"				
Layer Insul.	30	30				
Wrapper	12007VC	210056A				
TUBE	7L007		IMPREGNATION	VARNISH		
CURE	7/8 x 7/8	296	2x2	"D" MTG.		

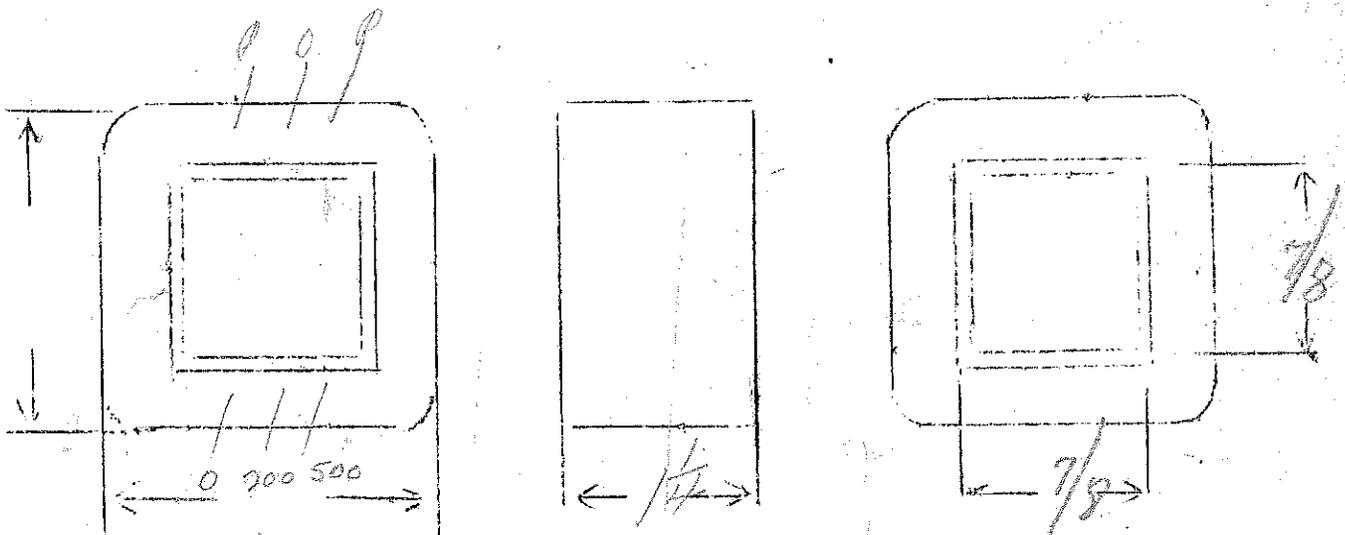

P.P. 245 (cable connected) to PP Parallel 2A3 grid

started
finish blue
start blue
finish red

SPEC. NO. 1907

Winding	PRI	SEC ₁	SEC ₂			
Turns	4400	2200	2200			
Taps	2200					
Wind. Lgth.	1.25	1.25	1.25			
Wire Size	#35	#35	#35			
T.P.L.	184-24	184-12	184-12			
Kind Term.	sec 24 Pwr 24	41 91				
Term. Lgth.						
Layer Insul.	30#	30#	30#			
Wrapper	1L007V6 3L007V6	1L007V6 3L007V6	2L005GA			
TUBE	7L007		IMPREGNATION	VARNISH		
CURE	1x 1 1/8		246a B/Guide	2x2		

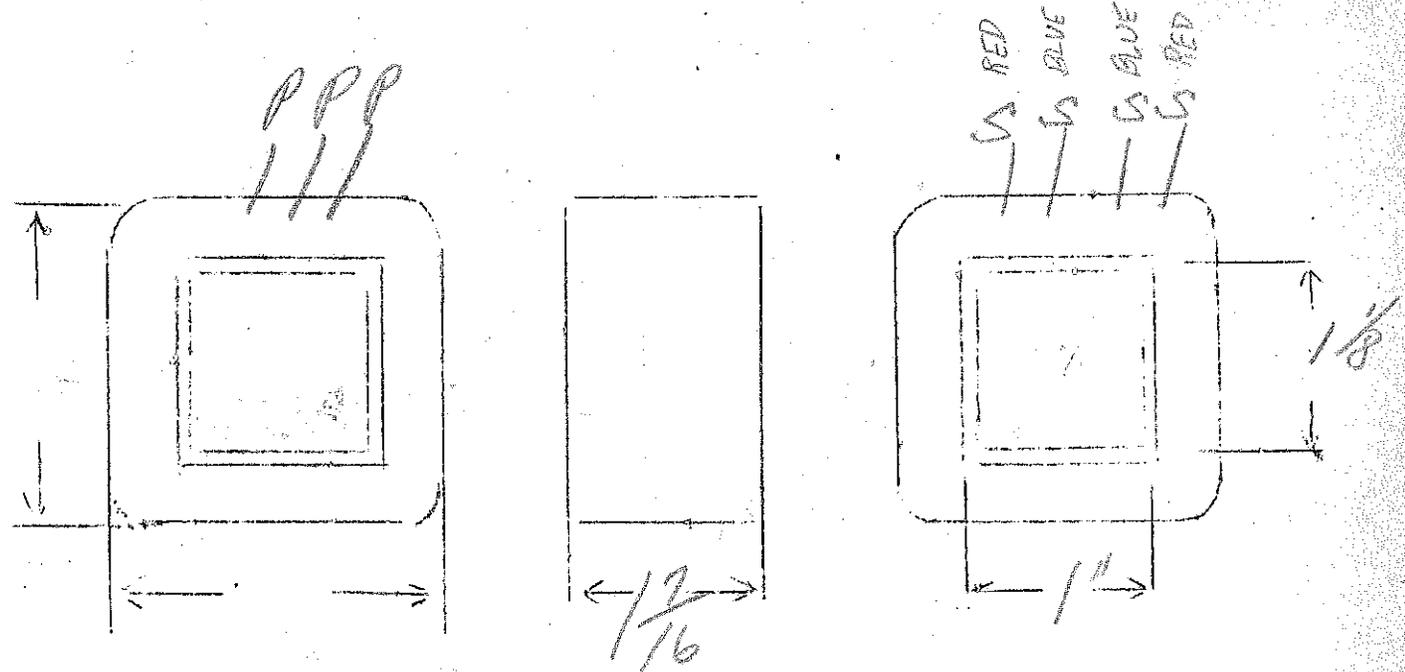

Check size
Be sure and wind tight

Primary Color Code		Secondary Color Code	
Start	Black	Start	Red
C. T.	White	C. T.	Blue
Finish	Black	Finish	Red

P 0 S1
 C.T. 0 0
 P 0 S2
 0 0

1.2 to 200 or 50 a

SPEC. NO. 1910

Winding	S ₁	P	S ₂			
Turns	430	60	430			
Taps	—	—	—			
Wind. Lgth.	3/4	3/4	3/4			
Wire Size	#33	21	#33			
T.P.L.	5L	3L	5L			
Kind Term.	sil Br	W.O.	sil Br			
Term. Lgth.	6	6"	6"			
Layer Insul.	30#	50#	30#			
Wrapper	1L005GA	1L005GA	2L005GA			
TUBE	42007	IMPREGNATION		Waf		
CURE	.6x6	2x2				

boat in sec starts

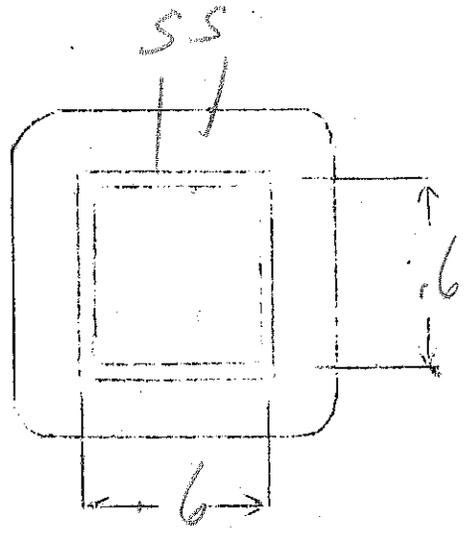
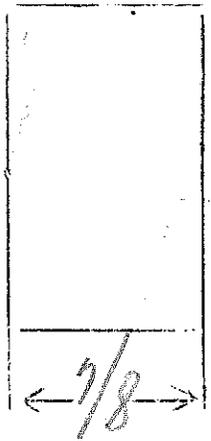
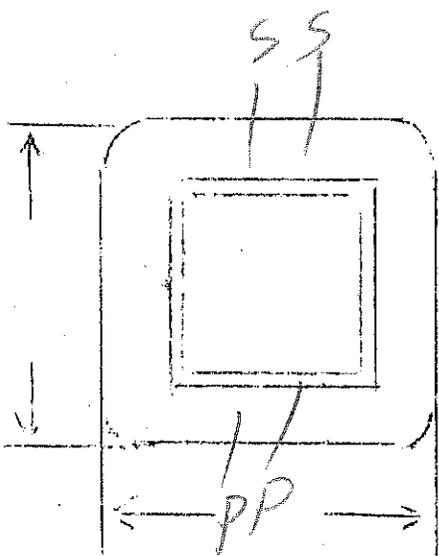

8 Ω to 15 Ω autotransformer

SPEC. NO. 1911

Winding	PRI						
Turns	312						
Taps	230						
Wind. Lgth.	1 1/16						
Wire Size	#21						
T.P.L.	33-10						
Kind Term.	WIRE ONLY						
Term. Lgth.	4"						
Layer Insul.	50#						
Wrapper	2L0050A						
TUBE	4/2007			IMPREGNATION		VARNISH	
CURE	7/8 17/8	2X2					

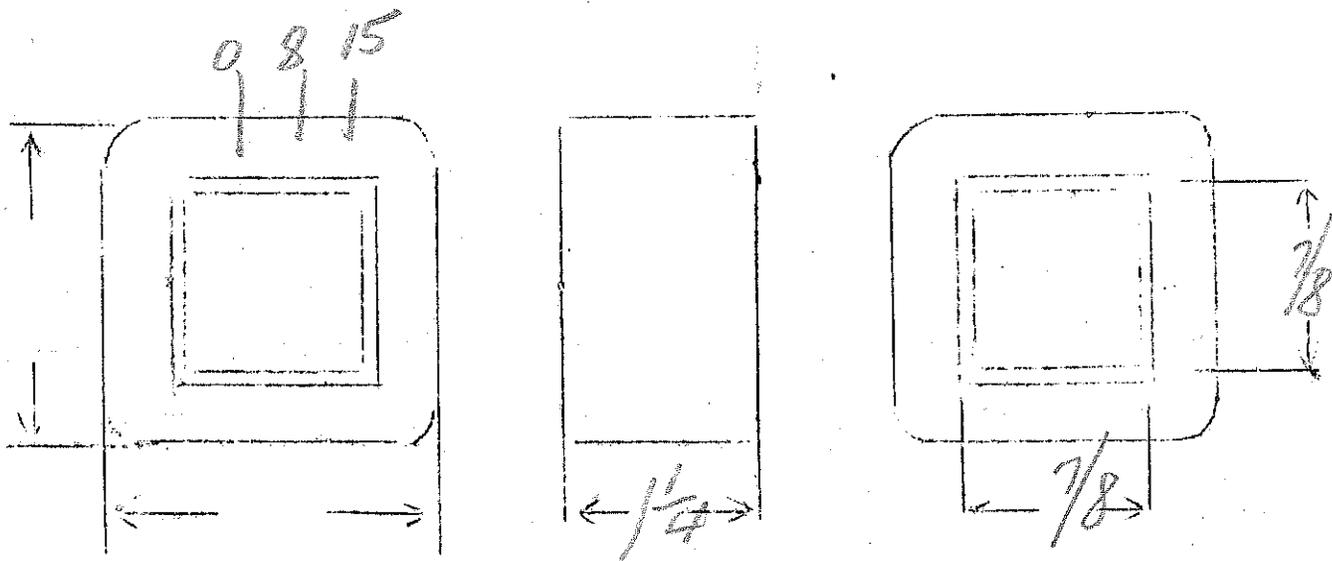

10000 Ω to 2004500 Ω

SPEC. NO. 1912

Winding	P	S				
Turns	5500	1230				
Taps		800				
Wind. Lgth.	1 1/8	1 1/8				
Wire Size	#38	#30				
T.P.L.	230-24	90				
Kind Term.	sil br.					
Term. Lgth.	3	3				
Layer Insul.	20#	30#				
Wrapper	1L007VC	2L0050A				
TUBE	7L007		IMPREGNATION		WAX	
CURE	1/8 x 7/8		2x2			

4.4
7

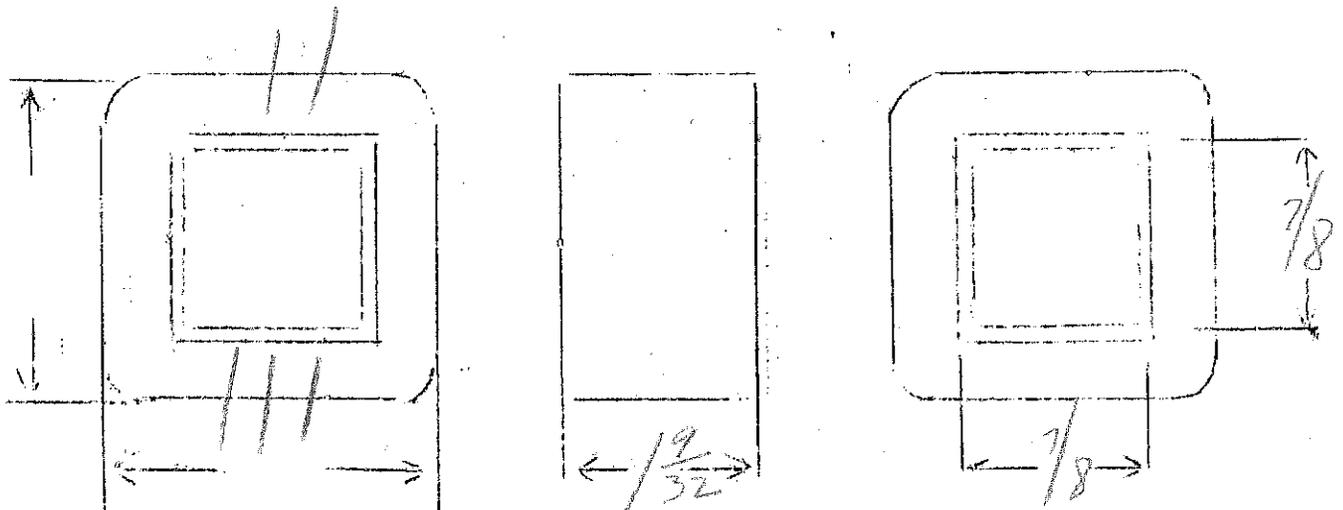

5 rts 2000 r

SPEC. NO. 1913

Winding	S	P				
Turns	2200	110				
Taps	-	-				
Wind. Lgth.	7/8	7/8				
Wire Size	#34	21				
T.P.L.	111-20					
Kind Term.	sil Brad WIRE ONLY					
Term. Lgth.	3	3				
Layer Insul.	30#					
Wrapper	2L0056A	2L0056A				
TUBE	7L007		IMPREGNATION	WAX		
CURE	3/4 X 3/4		290B grade 2x2			

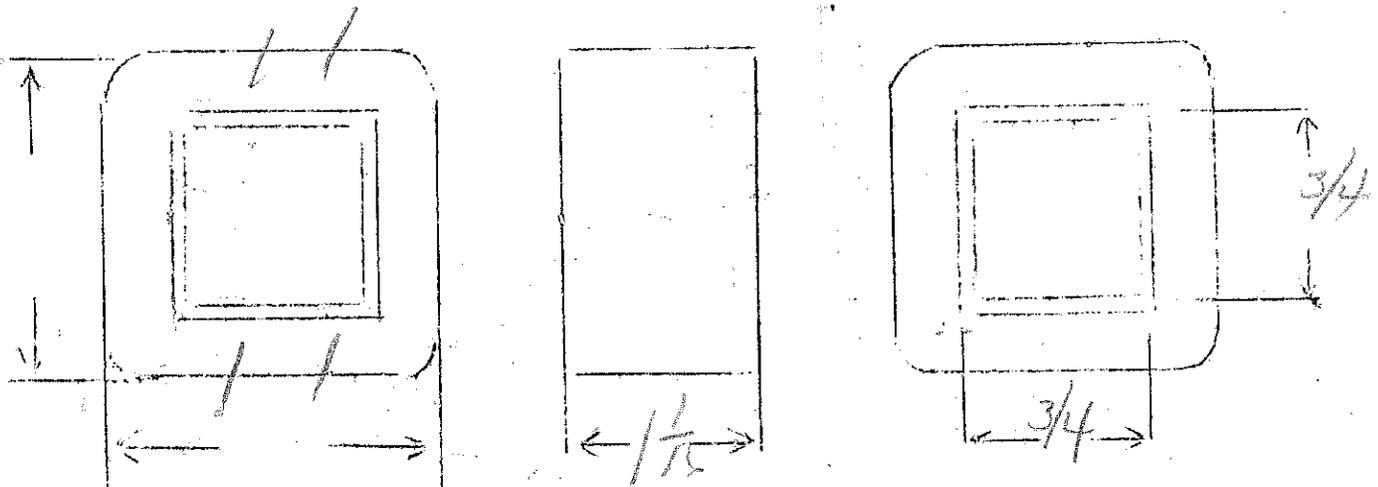

P.P. 6FL to 2.25 Ω v.c.

$$\frac{N_1}{N_2} = 79$$

14000 - CT to 2.25 Ω KC.

SPEC. NO.

1914

Winding	PRI	SEC				
Turns	4300	55				
Taps	2150	-				
Wind. Lgth.	7/8	7/8				
Wire Size	#36	#21				
T.P.L.	146-30	20-1				
Kind Term.	sil br	W. ONLY				
Term. Lgth.	3"	3"				
Layer Insul.	20#	40#				
Wrapper	2L0056A	2L0056A				
TUBE	4L007 <u>core</u>		IMPREGNATION	VARNISH		
CURE	3/4 x 3/4		2 x 2	B Grade		

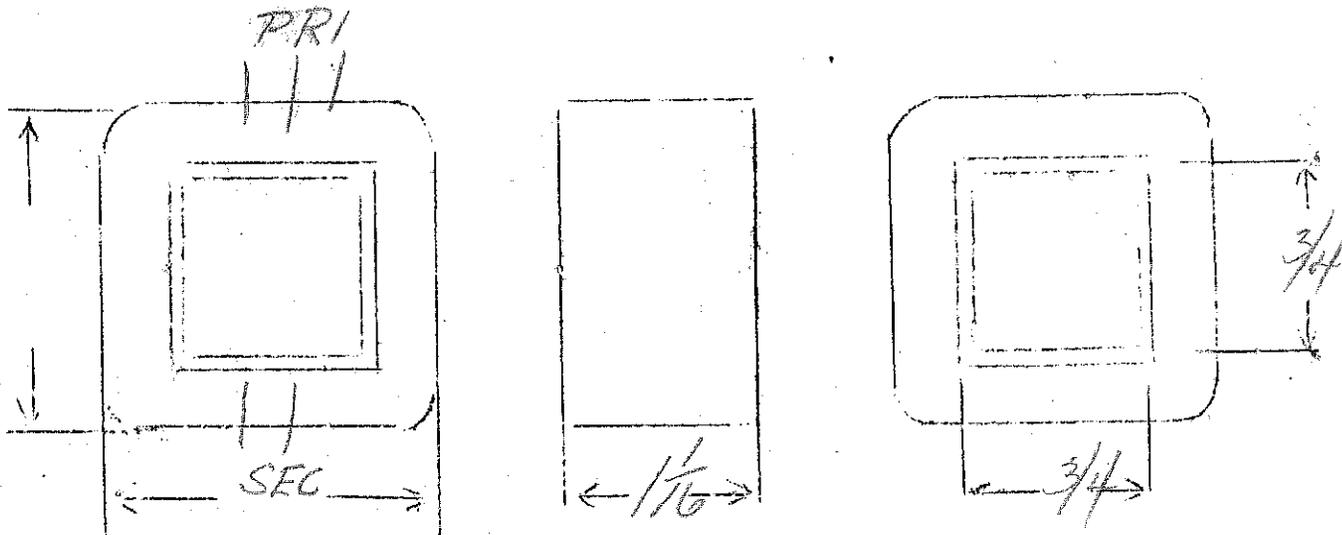

Parallel 2A3 to patient load



SPEC. NO. _____

1915

Winding	PRI	SEC				
Turns	2250	2200	2700			
Taps						
Wind. Lgth.	1 15/32	1 15/32	1 15/32			
Wire Size	#36	31	31			
T.P.L.	230-10	137-16	137-20			
Kind Term.	sil	braid				
Term. Lgth.	3"	3"	3"			
Layer Insul.	20#	30#	30#			
Wrapper		14007VC	260056A			
TUBE	72007		IMPREGNATION		VARNISH	
CURE	1/16" / 1/16"		2x2			

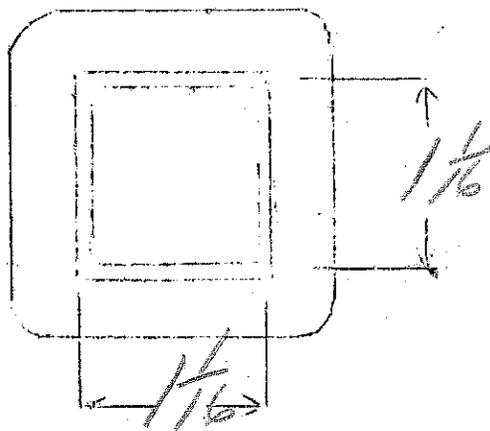
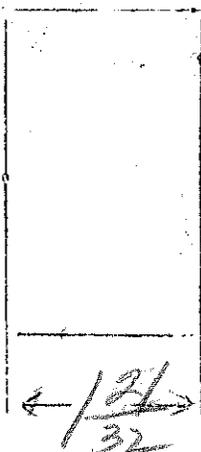
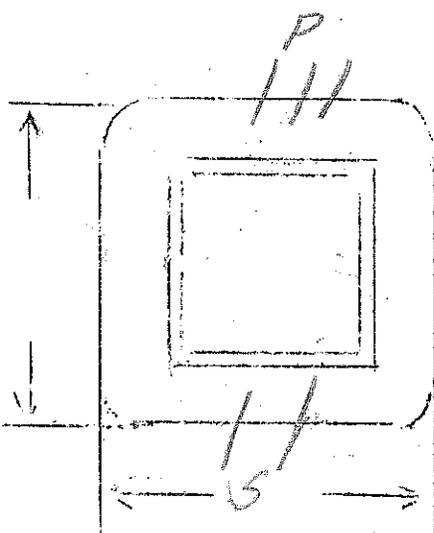

PP. 685 to 200 and 500 r.v.c.

SPEC. NO. 1916

	L.T. 1916						
Winding	PRI	SEC					
Turns	6000	860	490				
Taps	3000						
Wind. Lgth.	$\frac{15}{32}$	$\frac{15}{32}$	$\frac{15}{32}$				
Wire Size	#35	#27	#30				
T.P.L.	216-28	88-10	125-4				
Kind Term.	oil band						
Term. Lgth.	4"	4"	4"				
Layer Insul.	30 #	30 #	30 #				
Wrapper	12007VC		21005GA				
TUBE	42007			IMPREGNATION	VARNISH		
CURE	$1\frac{1}{16} \times 1\frac{1}{16}$	$\frac{1}{2} 296A$	$\frac{1}{2} 260A$	2x2			

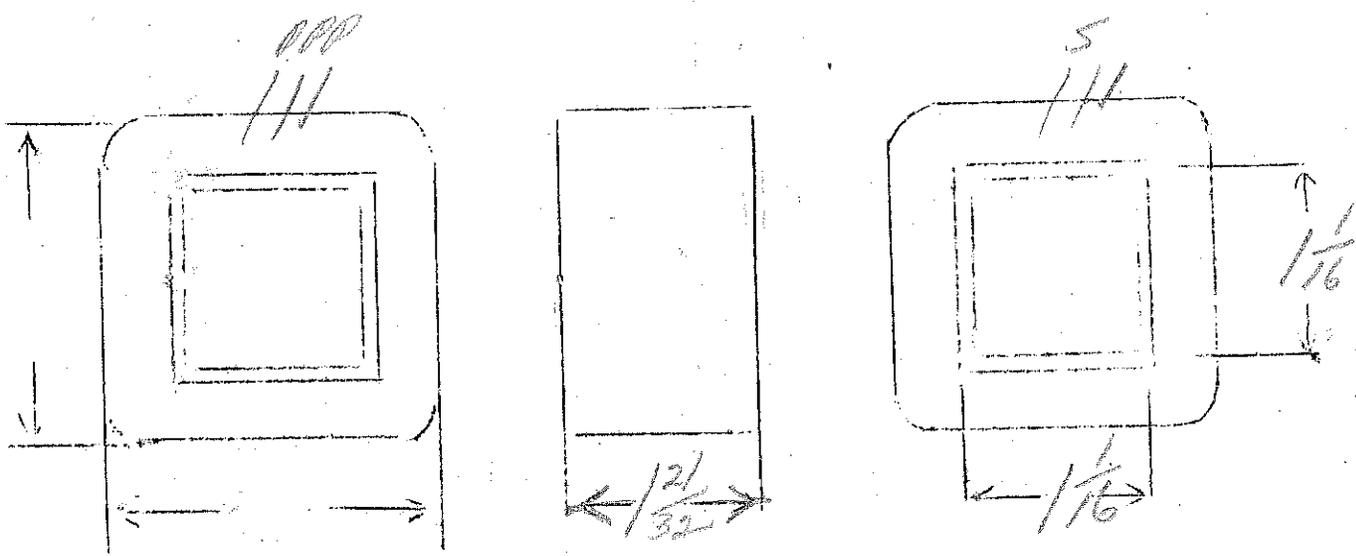

$$\frac{10000}{500} = 20$$

$$\frac{N_1}{N_2} = 4.45$$

$$\frac{10000}{200} = 50$$

$$\frac{N_1}{N_2} = 7$$

$$Z^2 = \frac{15}{500} = 30 \times 10^{-2}$$

$Z = 1.73$ amps #31

$$Z^2 = \frac{15}{200} = 7.5 \times 10^{-2}$$

$Z = 0.275$ amps #28

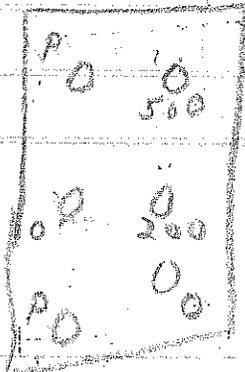

НОТЛАННАМ

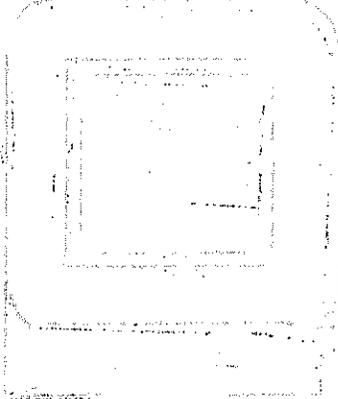

10000
 200
 15
 500
 15
 200
 10000
 500
 15
 500
 15
 200
 10000
 500
 15
 500
 15
 200

PP6F6 to 2.25 rvc

SPEC. NO. 1918

Winding	PRI	SEC					
Turns	4300	55					
Taps	2150	-					
Wind. Lgth.	7/8	5/8"					
Wire Size	#36	#23					
T.P.L.	146-30	4L					
Kind Term.	sil Brand	WIRE ONLY					
Term. Lgth.	3"	3"					
Layer Insul.	20#	40#					
Wrapper	2L005GA	2L005GA					
TUBE	4L007		IMPREGNATION			VARNISH	
CURE	3/4X1		298-9		2X2		

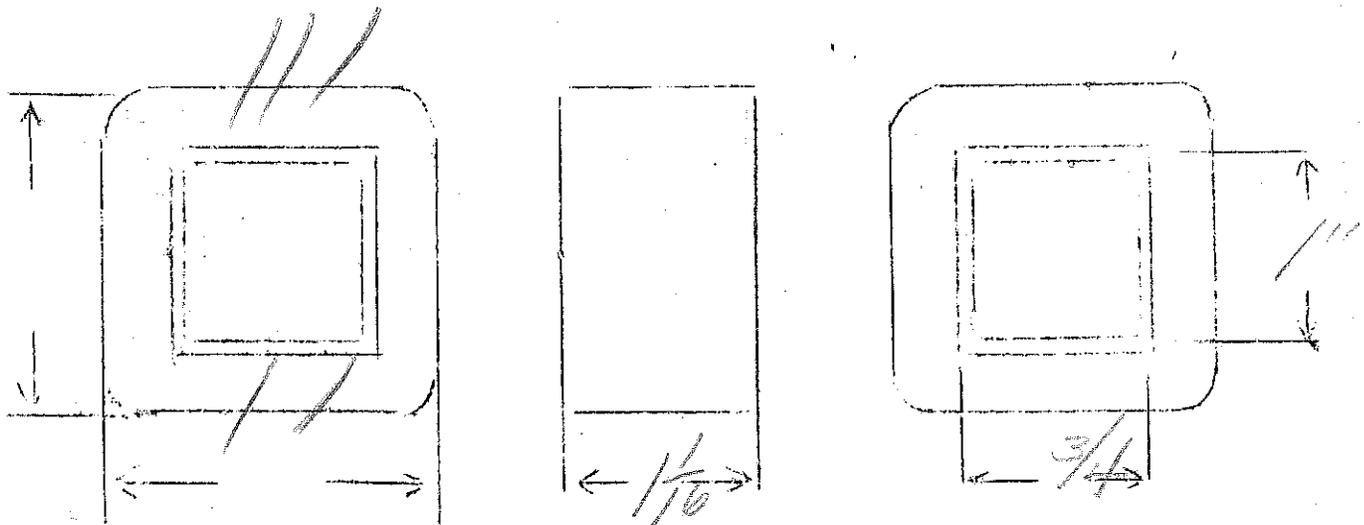

6AG Class A - PP connection to PP pipe

SPEC. NO. 1919

Winding	PR1	SEC				
Turns	6600	6000				
Taps	3300	3000				
Wind. Lgth.	15/16	15/16				
Wire Size	#39	#39				
T.P.L.	220	220				
Kind Term.	sil Braided					
Term. Lgth.	3	3				
Layer Insul.	12#	12#				
Wrapper	1/4" VEG 31 100	2L005GA				
TUBE	7L007	IMPREGNATION		VARVISE		
CURE	3/4 x 3/4	2x2				

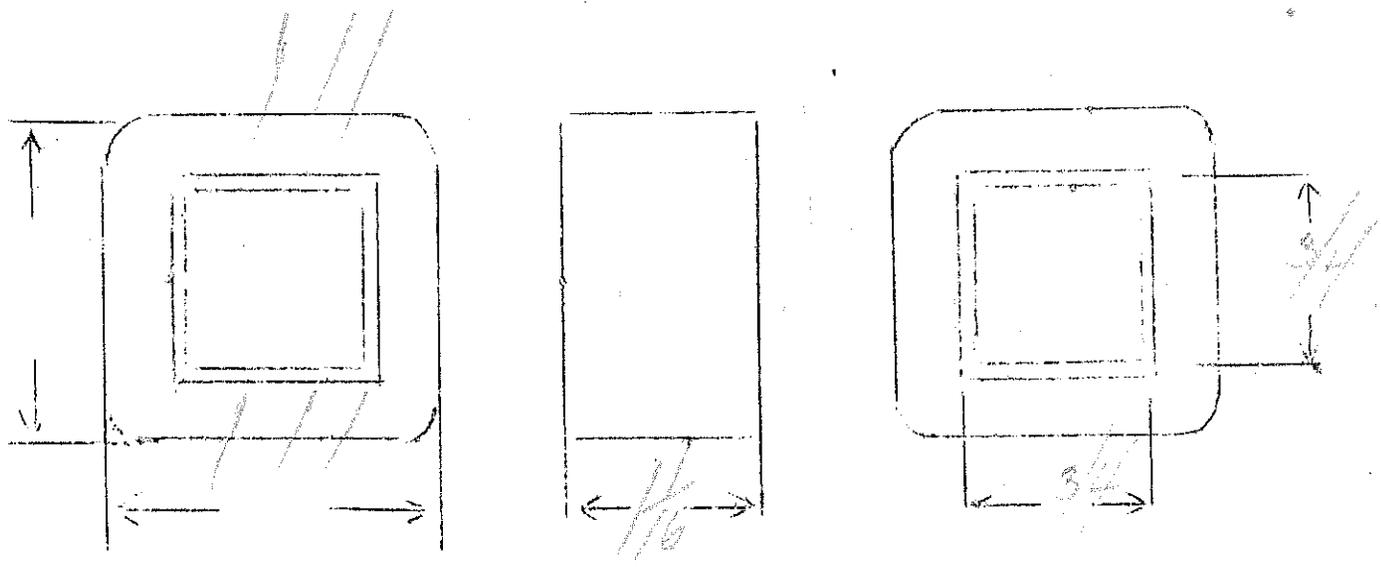

200 Ω to 2000 Ω

SPEC. NO. 1920

Winding	PR1	SEC				
Turns	1930	620				
Taps	—	—				
Wind. Lgth.	3/4	3/4				
Wire Size	37	30				
T.P.L.	138-14	62-10				
Kind Term.	sil Band					
Term. Lgth.	3	3"				
Layer Insul.	30#	12#				
Wrapper	20092C	20056A				
TUBE	42007		IMPREGNATION		WAX	
CURE	.6 X .6	2 X 2	296B			

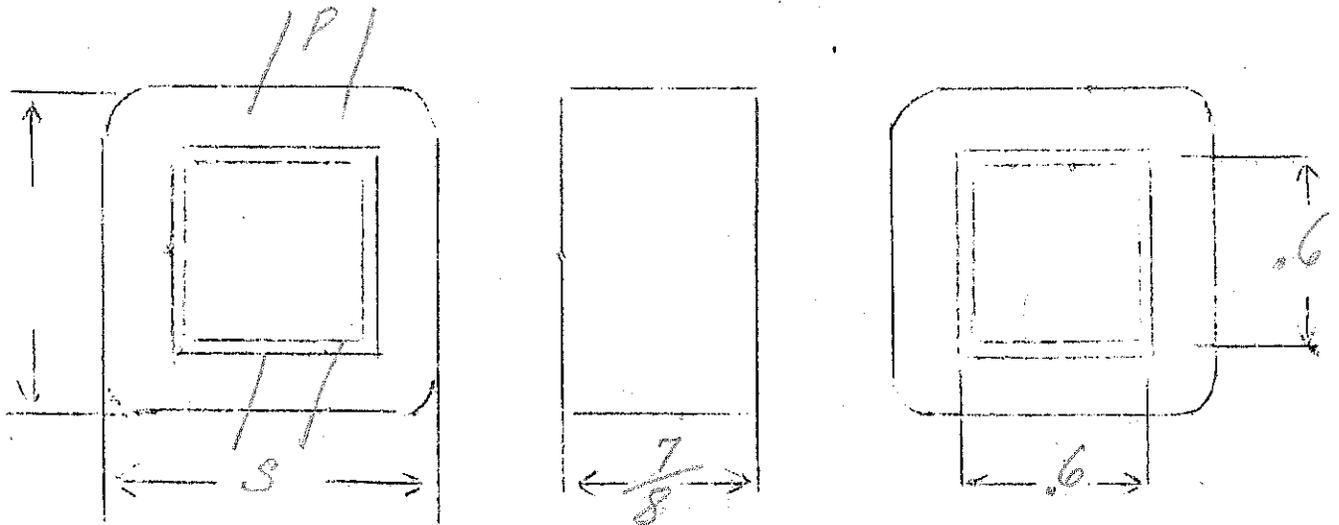

single plate to single grid 1.5 to 1 ratio

SPEC. NO. 1921

Winding	PRI	SEC				
Turns	2500	3750				
Taps	—	—				
Wind. Lgth.	3/4	3/4				
Wire Size	#38	#38				
T.P.L.	157	157				
Kind Term.	silver Braid					
Term. Lgth.	4"	4"				
Layer Insul.	12#	12#				
Wrapper	2007VC	21005GA				
TUBE	52007		IMPREGNATION		WAX	
CURE	.6 X .6	2 X 2				

no panel

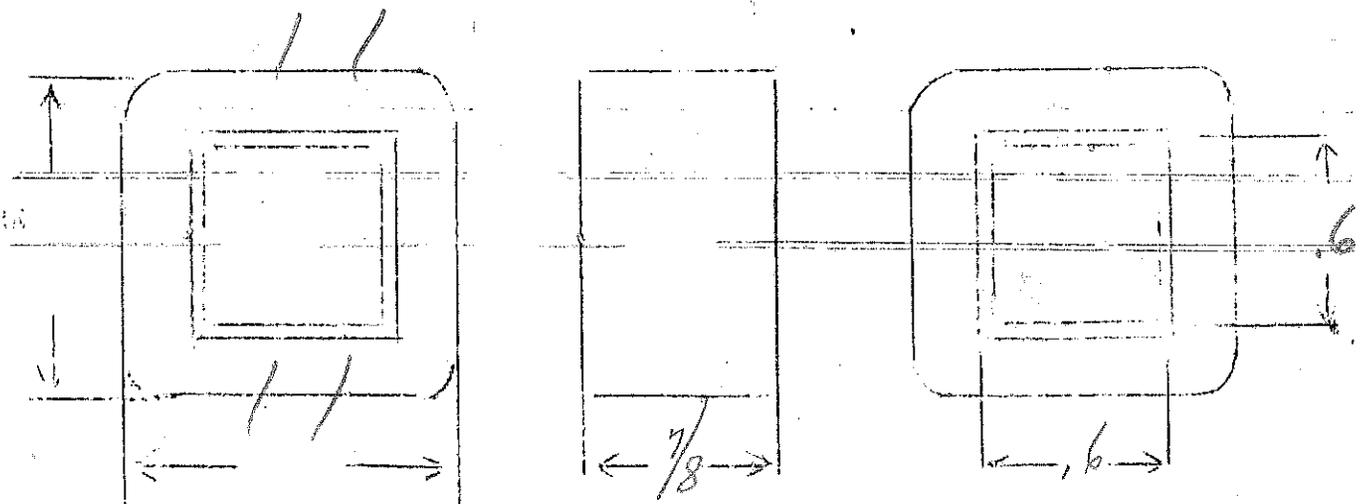

10,000 to 30,000 or 50,000
 operation at 50v

SPEC. NO. 1922

Continued

Winding	PRI	SEC				
Turns	5000	500	600			
Taps		256				
Wind. Lgth.	1/16	1/16	1/16			
Wire Size	#38	#27	#31			
T.P.L.	20-23	64-8	100-6			
Kind Term.	sil	bril				
Term. Lgth.	3"	3"	3"			
Layer Insul.	16#	30#	30#			
Wrapper	2007VC		2005EA			
TUBE	72007		IMPREGNATION		WAX	
CURE	3/8 x 7/8 Butt Seal rogs					

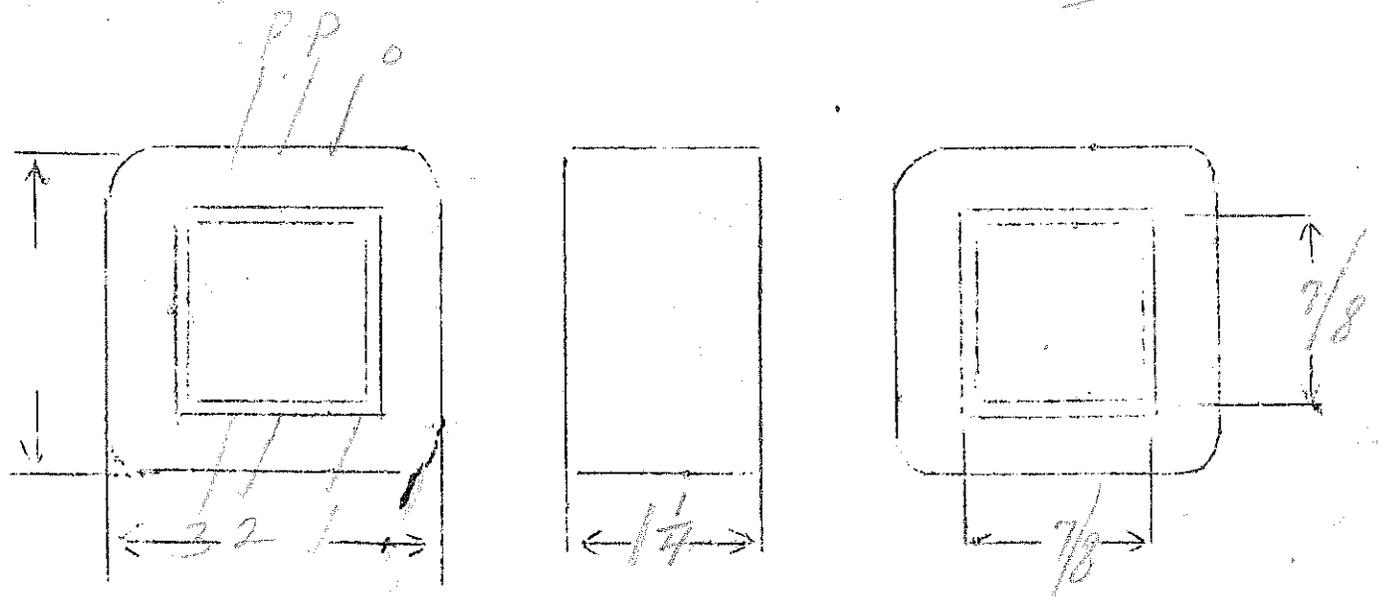

each pri 3.5H CT - E-Plans

SPEC. NO. 1923

Winding	P	S					
Turns	950	950					
Taps	—	—					
Wind. Lgth.	3/8	3/8					
Wire Size	36	36					
T.P.L.	64	64					
Kind Term.	fil	brnd					
Term. Lgth.	3	3					
Layer Insul.	16	16					
Wrapper	16007VC	200050A					
TUBE	7L007		IMPREGNATION			WAX	
CURE	3/4X 3/4		290A		2X2		

2 pri - 2 sec

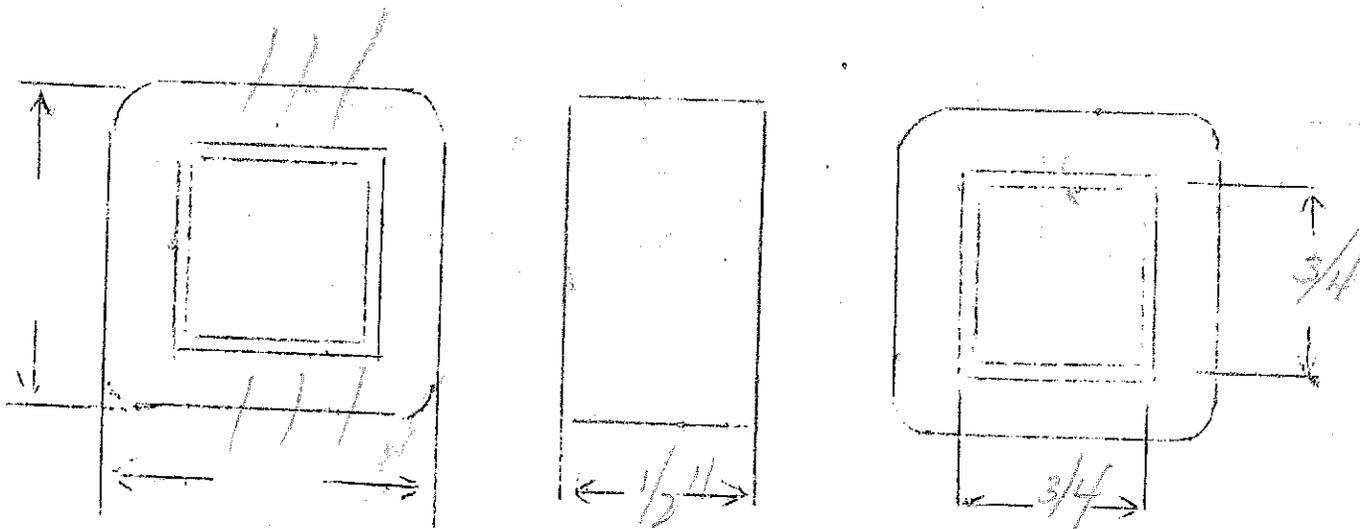

Reverse Assembly

Handwritten text at the top center of the page.

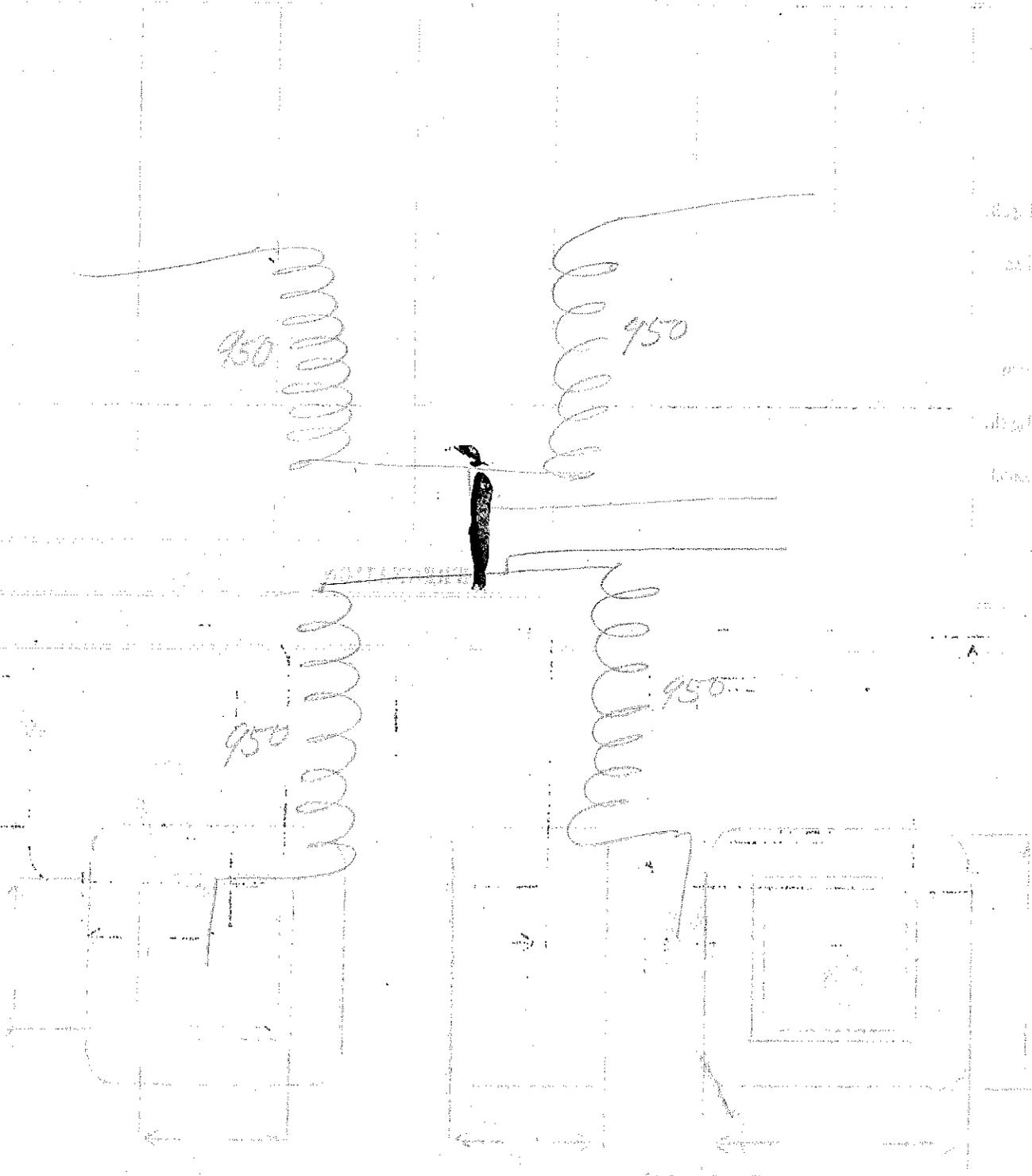

Faint, illegible text on the right side of the page, possibly bleed-through from the reverse side.

50 (SEC) 200 (SEC) 200 (SEC) 200 (SEC) 200 (SEC) 50 (SEC)

(000000) (000000)
Grid Grid

SPEC. NO. 1924

Winding	SEC	PRI					
Turns	6200	240	480	480	480	480	240
Taps	—	—	—	—	—	—	—
Wind. Lgth.	14 1/32	15 1/32	—	—	—	—	—
Wire Size	#40	#30	—	—	—	—	—
T.P.L.	151-42	123-2	4	4	4	4	2
Kind Term.	Silver Brand						
Term. Lgth.	6"	6"	6"	6"	6"	6"	6"
Layer Insul.	16#	30#	—	—	—	—	—
Wrapper	12005VP 22005EA	12005VP	12005VP	12005VP	12005VP	12005VP	22005EA
TUBE	72007		IMPREGNATION			WAX	
CURE	1 1/4 x 3/4 290 "A" Grid 212						

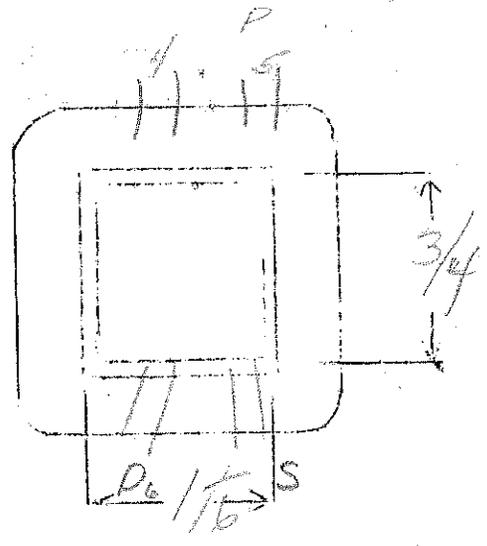
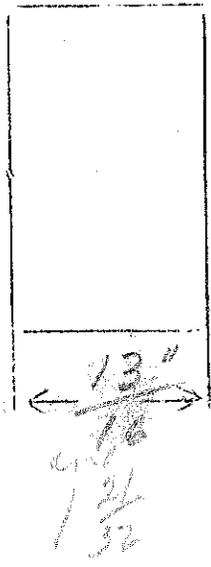
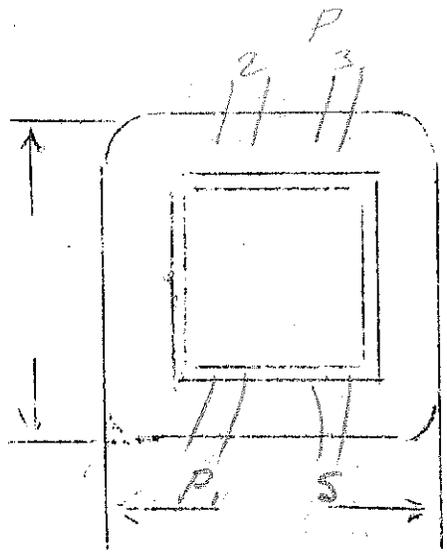

PP6B5 to 8000 Ω Modulator
to modulate 2-89 tubes

Sec 2500 Ω Ins

SPEC. NO. 1925

Winding	PRI	SEC				
Turns	3960	3400				
Taps	1980	—				
Wind. Lgth.	1 3/8	1 3/8				
Wire Size	#34	#32				
T.P.L.	181-22	142-24				
Kind Term.	silver	brass				
Term. Lgth.	4"	4"				
Layer Insul.	30#	46#				
Wrapper	2L007C	2L007C				
TUBE	7L007		IMPREGNATION	VARNISH		
CURE	1 1/16 x 1 1/2		42296a	42266a	gyp. 010	

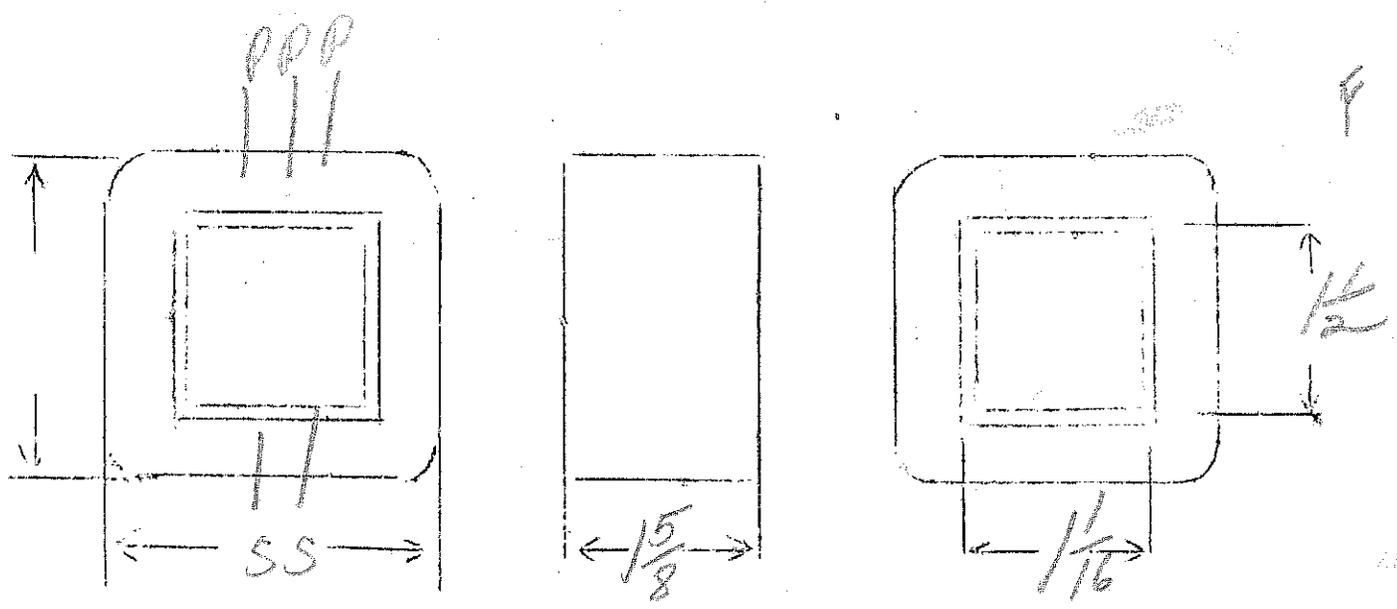

$$\frac{10000}{8000} = \frac{50}{40} = 1.25 \quad \frac{N_1}{N_2} = 1.12$$

P
O
C
T
O
P
O

8000
G
O



20000 a plate (66 thickness) to 1.0 VC.

SPEC. NO. 1926

Winding	PR1	SHIELD	SEC			
Turns	10,000	1	73			
Taps	—		—			
Wind. Lgth.	1.25	1.25	1.25			
Wire Size	#38	SHIM STOCK	#20			
T.P.L.	266-38	—				
Kind Term.	Black Par Br	Sil Braid	WIRE ONLY	white	lamina	
Term. Lgth.	10"	3"	10"			
Layer Insul.	16#	—	.005			
Wrapper	2L005GA	2L005GA	2L005GA			
TUBE	7L007			IMPREGNATION	VARNISH + WAX	
CURE	1X-6	22	29 ga	A Grade	Dip Lamination	

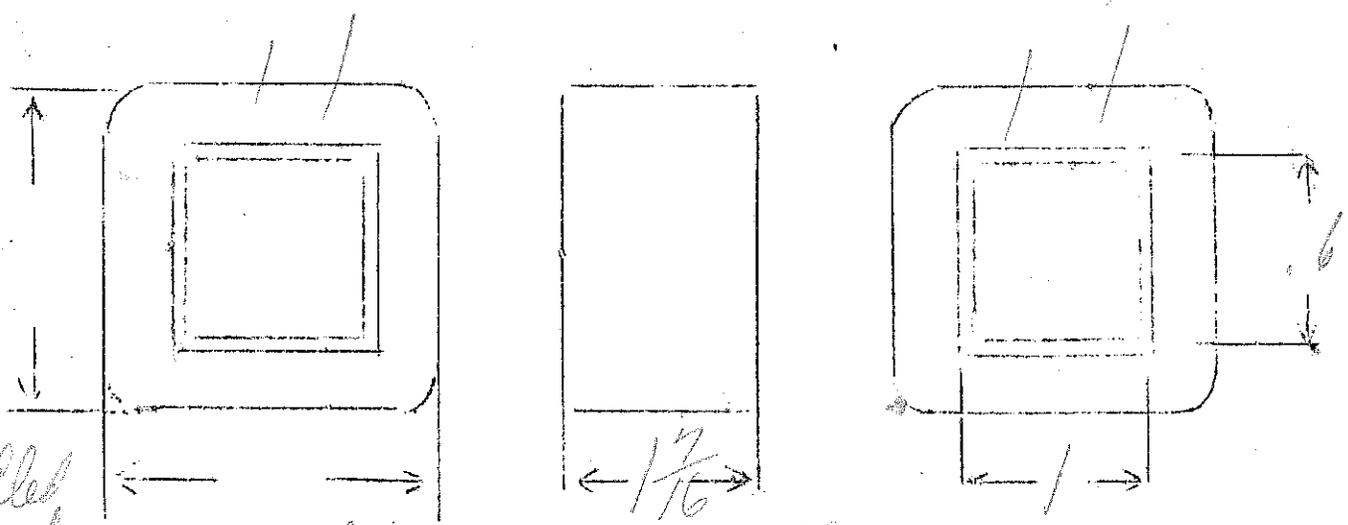

mtg - 4A filled with wax

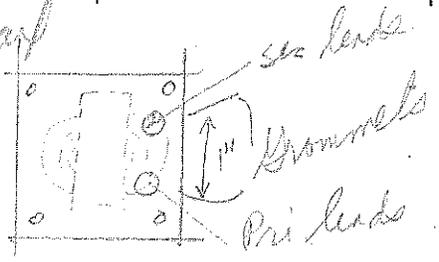

Tap to have 18 ga. cover with two grommets for leads

5000 or pu - 60MA to 500 a line
30-10,000 cycles

SPEC. NO. 1927

Winding	SEC	PRI				
Turns	630	4000				
Taps	—	—				
Wind. Lgth.	1/2"	1/2"				
Wire Size	#31	#38				
T.P.L.	46-14	102-40				
Kind Term.	#20 R. brake					
Term. Lgth.	9"	9"				
Layer Insul.	30#	20#				
Wrapper	1L007VC	2L005GA				
TUBE	7L007		IMPREGNATION	VARNISH		
CURE	1X1	095A Guide	003" gap			

Finish leads inside of coil

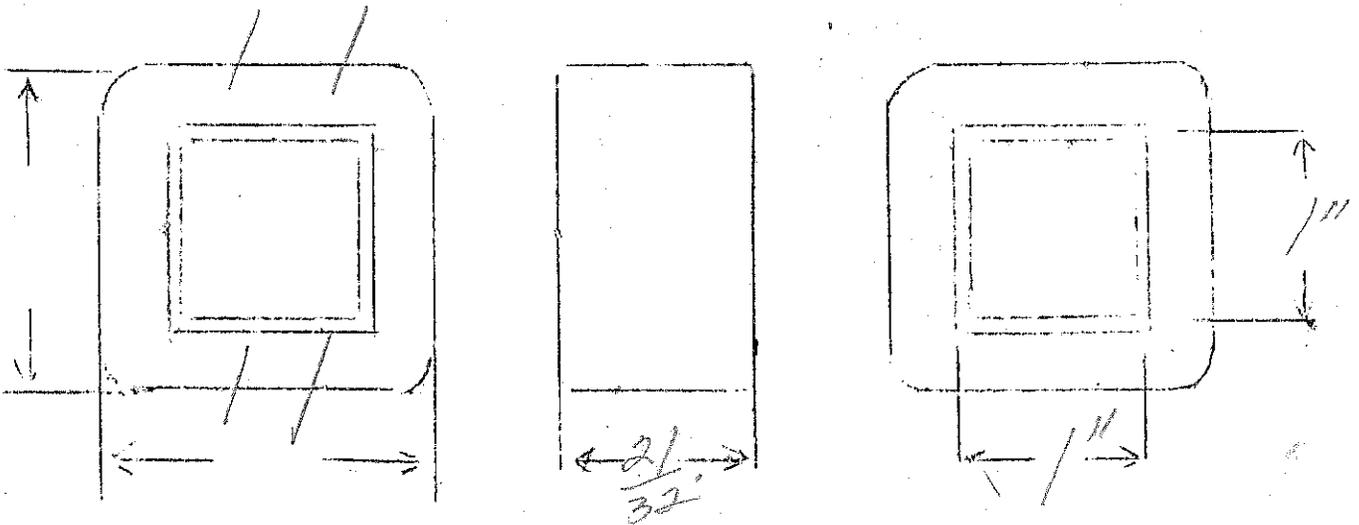

$$\frac{N_1}{N_2} = \sqrt{\frac{5000}{500}} = \sqrt{10} = 3.16$$

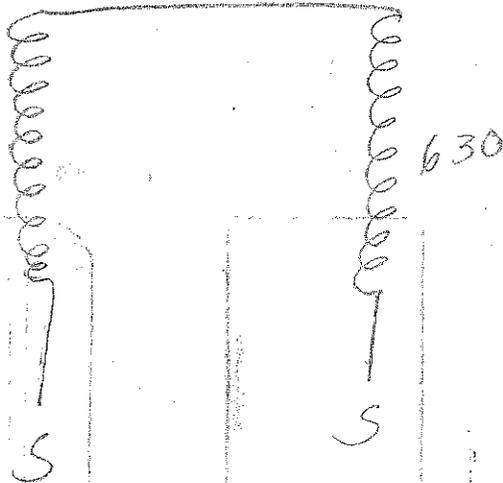
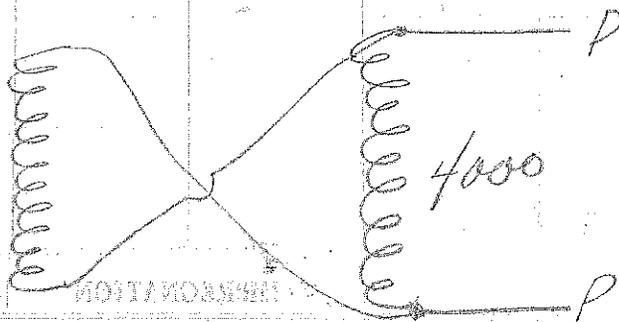

Reverse Assembly

Single 6F6 triode connected driver to 2-pp AB
 pentode connected 6F6's in Fifer Bias
 Pri-31MA-10000Ω P: 1/2 SEC = 3.32

SPEC. NO. 1928

Winding	PRI	SEC				
Turns	3600	2200				
Taps	—	—				
Wind. Lgth.	1/2"	1/2"				
Wire Size	#37	#37				
T.P.L.	95-38	95-24				
Kind Term.	Sil Braid					
Term. Lgth.	4"	4"				
Layer Insul.	20#	20#				
Wrapper	1000Vc 3. Blum	210050A				

TUBE 71007 IMPREGNATION VARNISH

CURE 1x 7/8 .003" Gap 2950 A Grade

all leads out - jump pins in assembly

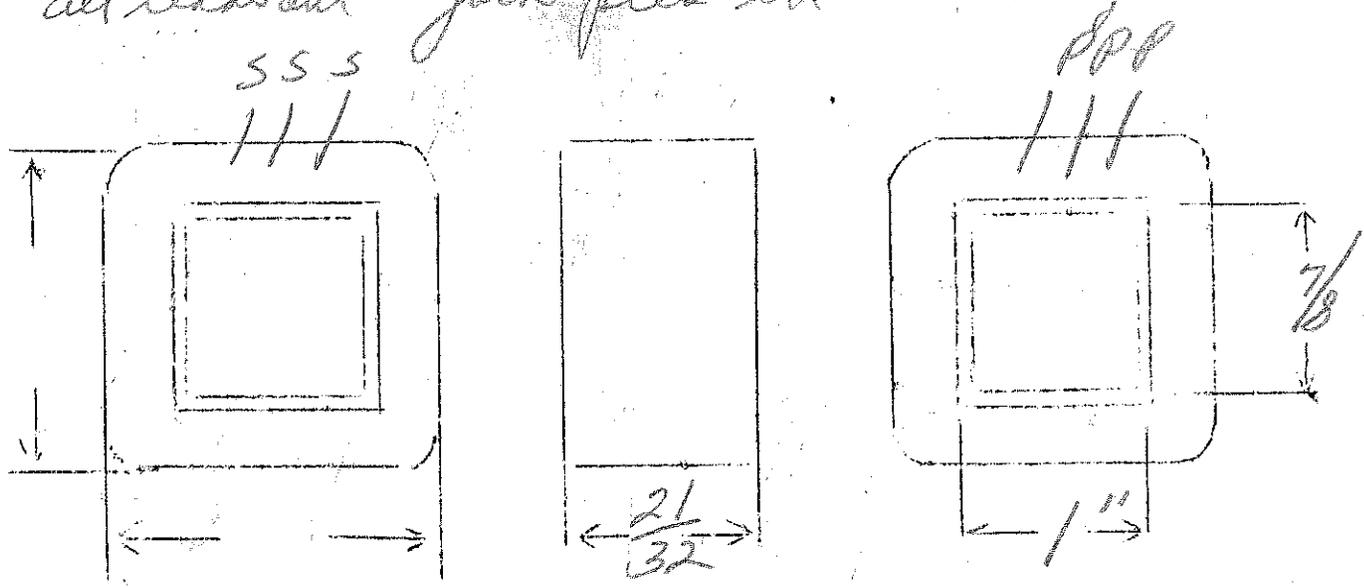

WINDING

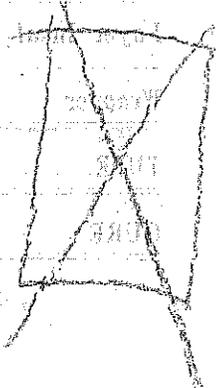
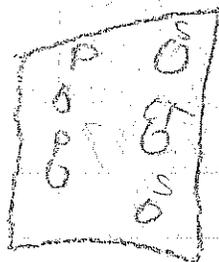
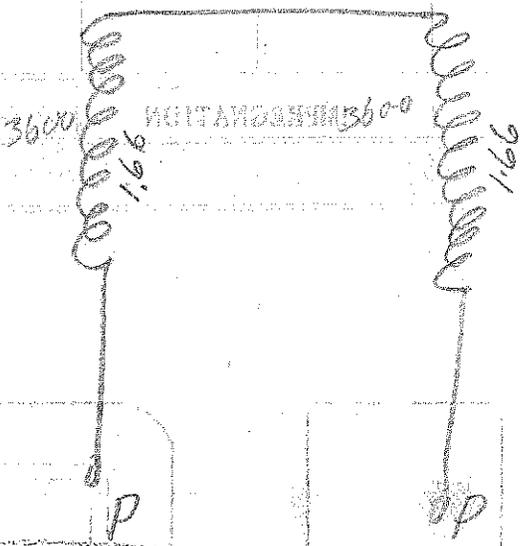
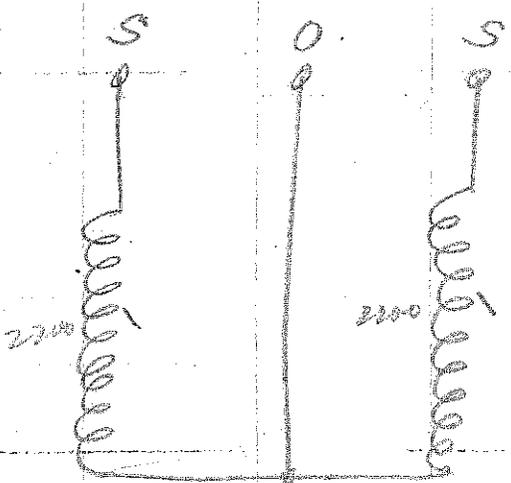

iron

REVERSE ASSEMBLY

Special Parallel 2A3 oscillator transformer

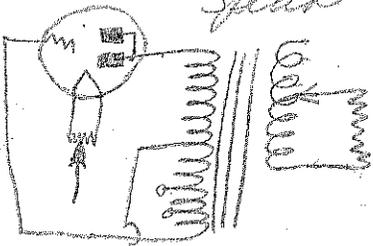

SPEC. NO. 1929

Winding	PRI	SEC	Sec #2			
Turns	3960 1980	2100 1830	3000			
Taps	1650 1530	1570 1310	2700 2400 2100			
Wind. Lgth.	1.25	1.25	1.25			
Wire Size	#34	32	#33E			
T.P.L.	165-24	132-	150-			
Kind Term.	silver	brad				
Term. Lgth.	3"	3"				
Layer Insul.	30#	30#				
Wrapper	16007C	21005A				
TUBE	71007		IMPREGNATION	VARNISH		
CURE	1X1	266a	Both	stack .005 gap		

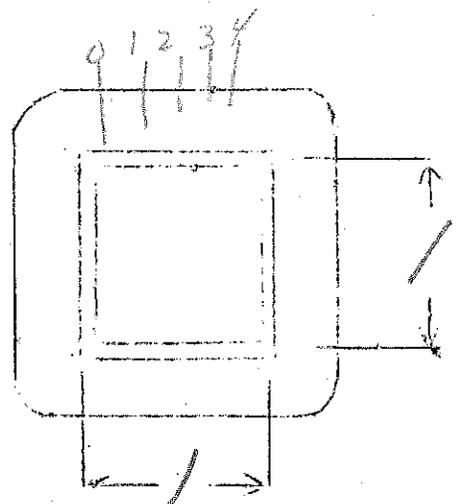
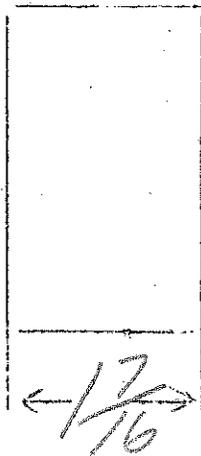
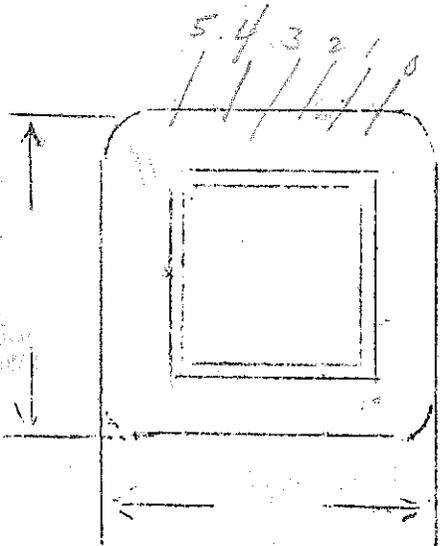

Single 6F6 triode connected driver to
 2-P.P AB pentode connected 6F6's in push pull
 Pri 31ma - 10,000 Ω
 $\frac{P}{I_{sec}} = 3.32$ SPEC. NO. 1930

Winding	PRI	SEC				
Turns	3280	2000				
Taps	—	—				
Wind. Lgth.	7/16	7/16				
Wire Size	#37	#39				
T.P.L.	82-40	100-20				
Kind Term.	silver braid					
Term. Lgth.	3"	3"				
Layer Insul.	16#	16#				
Wrapper	1007 KC 31 pt.	2205 GA				
TUBE	7L007		IMPREGNATION		VARNISH	
CURE	7/8 x 7/8		.003" Gap			

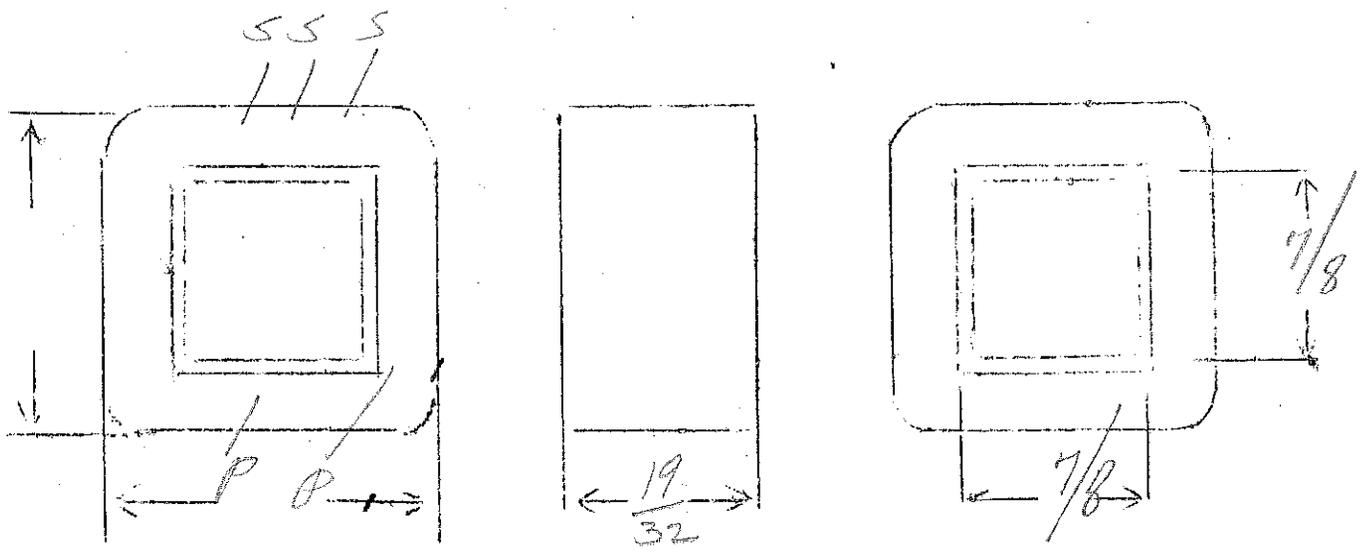

1000

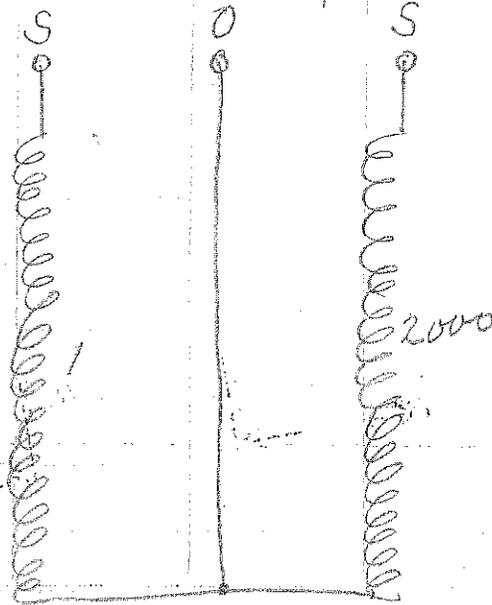

1000

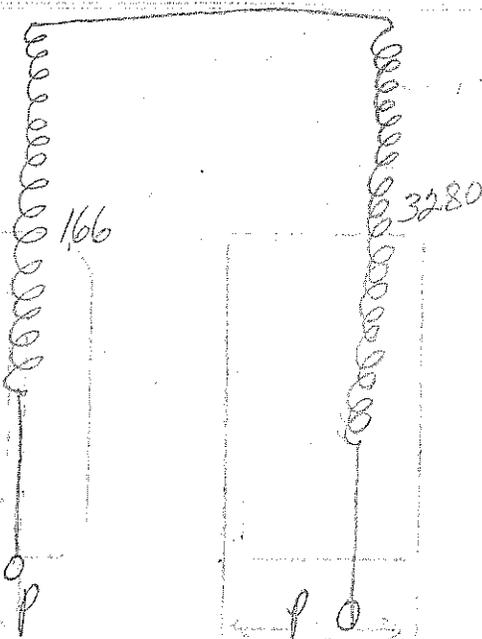

Pri - 1000 Ω
 Sec - 25000 Ω

+20B audio

SPEC. NO. 1931

Winding	PRI	SEC				
Turns	1150	5750				
Taps	—	—				
Wind. Lgth.	1 1/16	1 1/16				
Wire Size	#30	#38				
T.P.L.	88-13	222-26				
Kind Term.	#20 Brand	#20 Brand				
Term. Lgth.	9"	9"				
Layer Insul.	30#	20#				
Wrapper	10007V	20056A				
TUBE	76007		IMPREGNATION		VARNISH	
CURE	7/8 x 7/8	2x2				

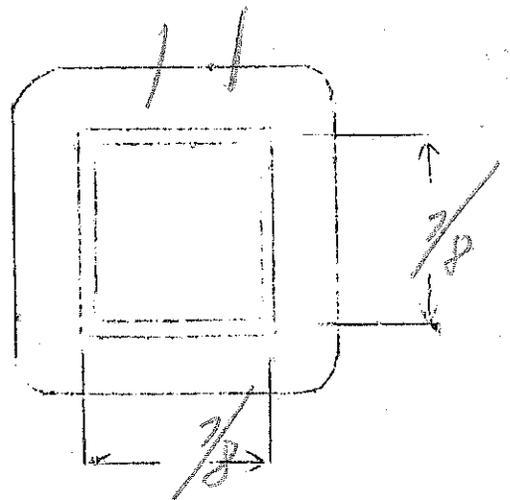
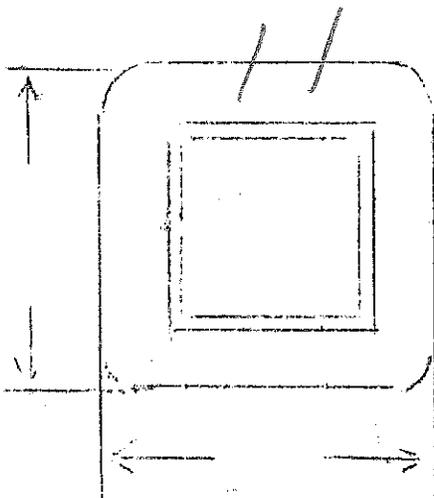

6F6 pt to mag. spher
60,000 - 3000

SPEC. NO. 1932

Winding	PRI	SEC				
Turns	7000	1560				
Taps	—	—				
Wind. Lgth.	1 1/16	1 1/16				
Wire Size	#39	#31				
T.P.L.	250-28	100-16				
Kind Term.	sil	Braid				
Term. Lgth.	3"	3"				
Layer Insul.	16#	30#				
Wrapper	2007V	20056A				
TUBE	2007		IMPREGNATION:		VARNISH	
CURE	7/8 x 7/8		2 x 2			

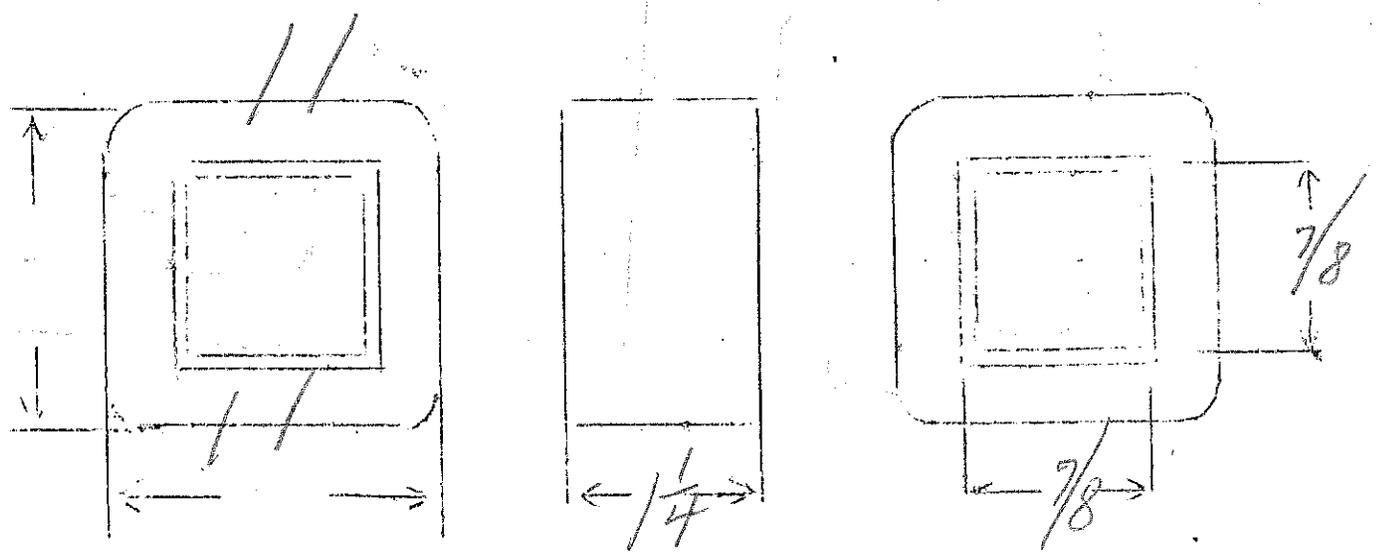

PP Class B 210, 830, 841 plates to modulators
 4,500 or 18,000 Ω
 and 50 Ω monitor winding

1.33

Sec 5000 V. Ins.

SPEC. NO. 1933

Winding	PRI	SEC ₁	SEC ₂	SEC ₃		
Turns	3400	2600	2600	265		
Taps	1700	-	-	-		
Wind. Lgth.	15/8	15/8	15/8	15/8		
Wire Size	#32	#32	#32	#36		
T.P.L.	170-20	170-16	170-16	265-1		
Kind Term.	sil braid - leads placed in winding					
Term. Lgth.	5"	5"	5"	5"		
Layer Insul.	double 16#	double 16#				
Wrapper	21007VC 35 glass	21007VC	21007VC 10076A	210076A		
TUBE	72007 + 12007VC			IMPREGNATION	VARNISH	
CURE	1 1/4 x 2 1/2		Temp. 810" 260a			

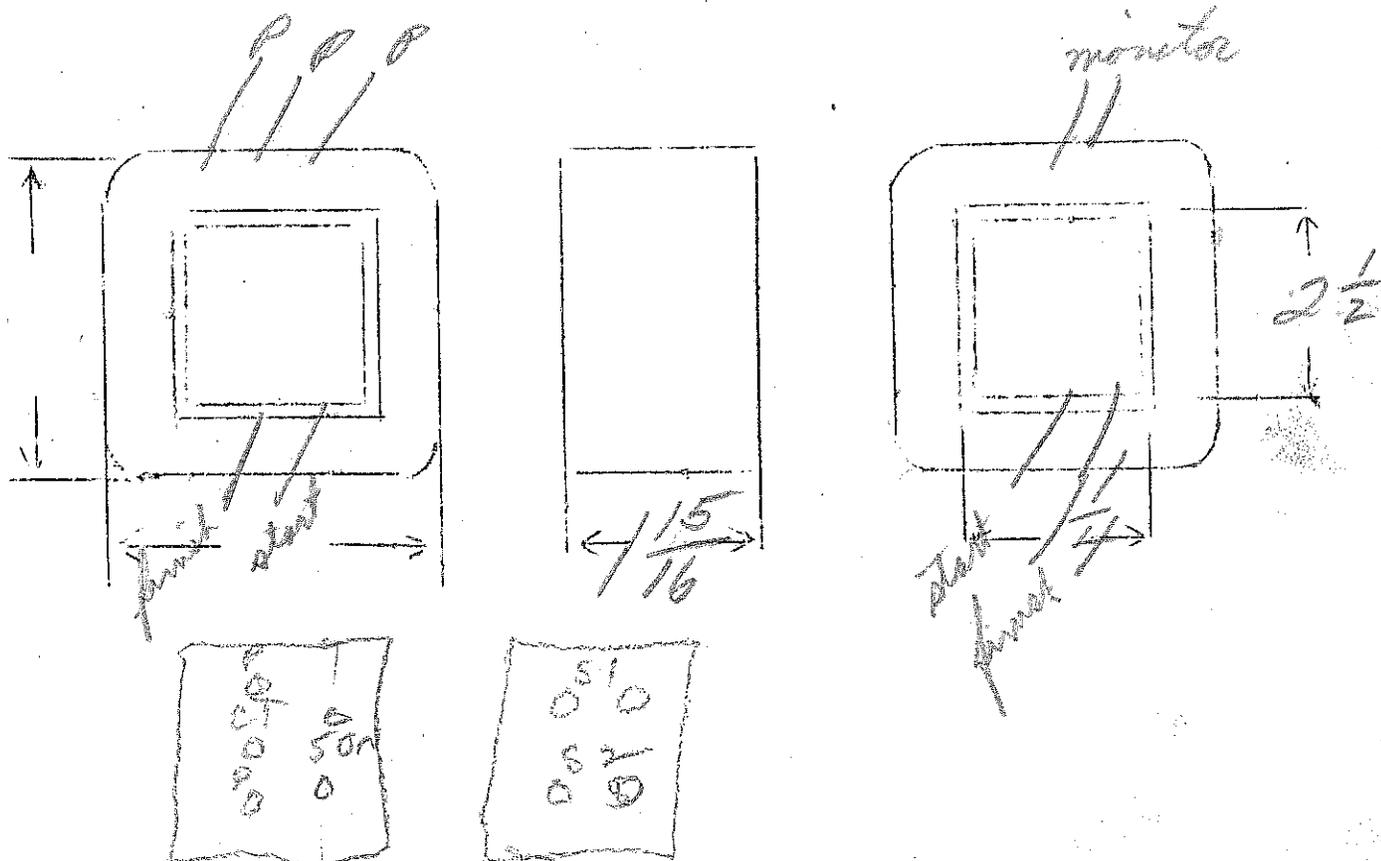

2 - 250 class A to modulate 2 - 225 class C

5000 or 10000

Pri - 25 with audio

Sec - 200 Ma - 5000V Dns.
 Pri - 8000 ohm P-P
 SPEC. NO. 1934

Winding	PRI	SEC				
Turns	3800	4140	10,000			
Taps	1900	3020	5000			
Wind. Lgth.	1 5/8	1 5/8				
Wire Size	#33	#30				
T.P.L.	192-20	138-30				
Kind Term.	WIRE	ONLY				
Term. Lgth.	3"	3"				
Layer Insul.	30#	30#				
Wrapper	200 VC	200 VC				
TUBE	7207			IMPREGNATION		VARNISH
CURE	1 1/4 x 1 1/4	1/2 2000	1/2 2960			Exp. 020

wind carefully - 5000V. Dns. sec.

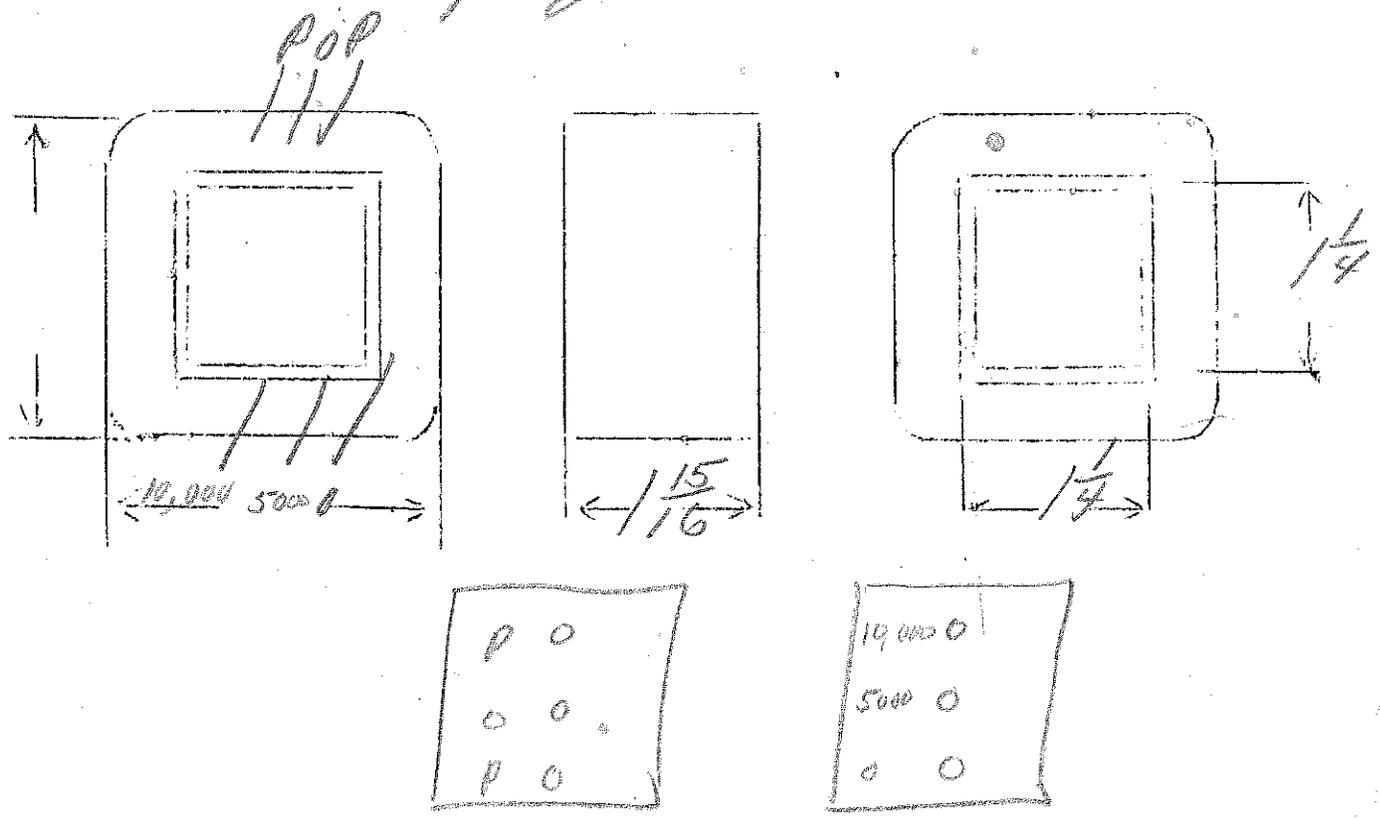

5000
or
3000 Ω to 2 class B 210 grids

SPEC. NO. 1935

Winding	PR1		SEC			
Turns	4940 4370		3550			
Taps	2470 570		1775			
Wind. Lgth.	$1\frac{15}{32}$		$1\frac{15}{32}$			
Wire Size	#34		#34			
T.P.L.	190		190			
Kind Term.	sil braid					
Term. Lgth.	4"		4"			
Layer Insul.	40#		40#			
Wrapper	12007VC		2L005 GA			
TUBE	7L007		IMPREGNATION		VARNISH	
CURE	$1\frac{1}{2}$ $1\frac{1}{2}$		242		29 da B	

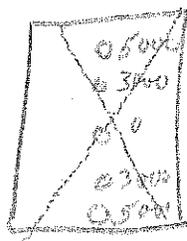
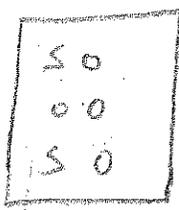
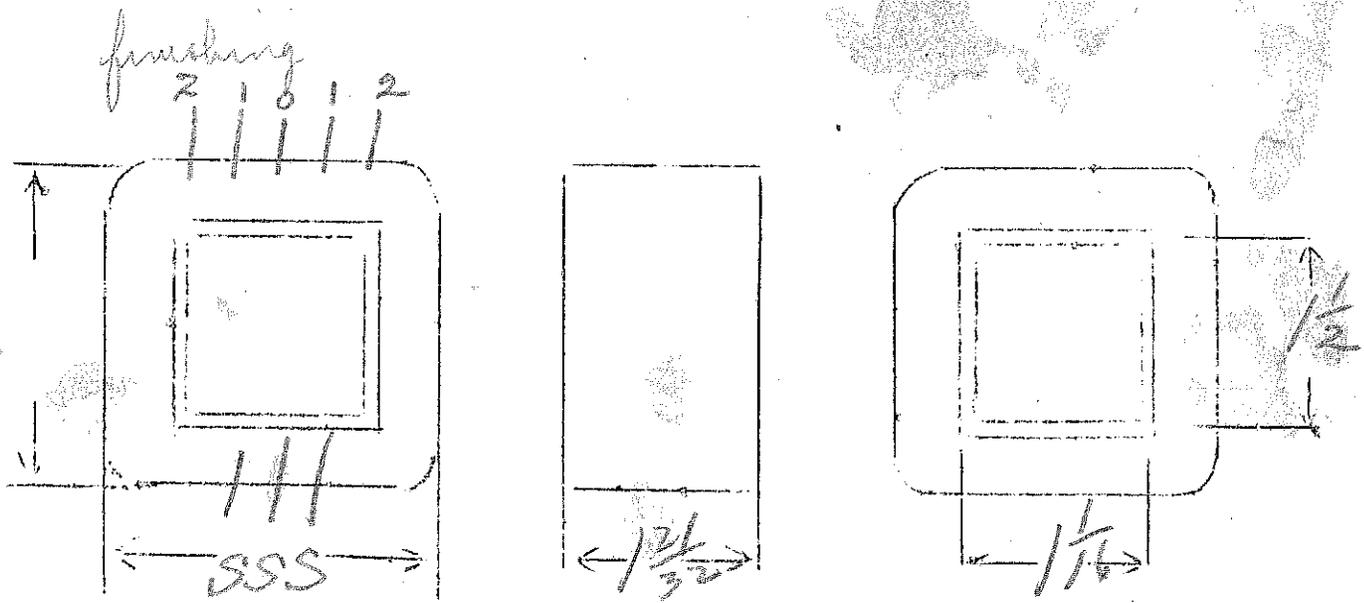

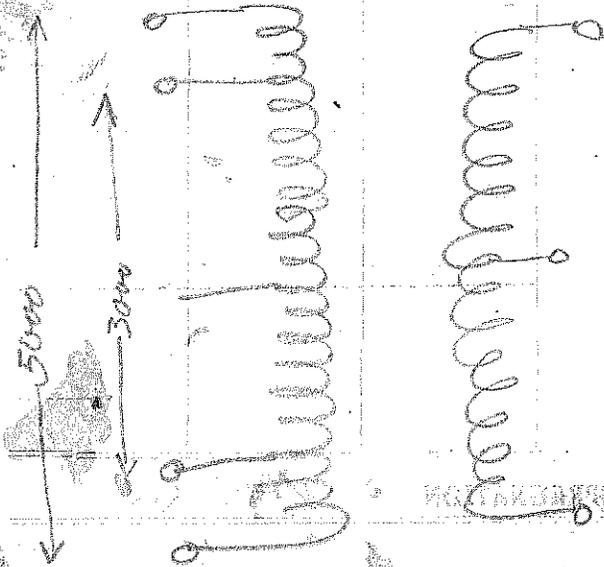

$$\frac{5000}{3000} = 1.66 \quad \frac{N_1}{N_2} = 1.28$$

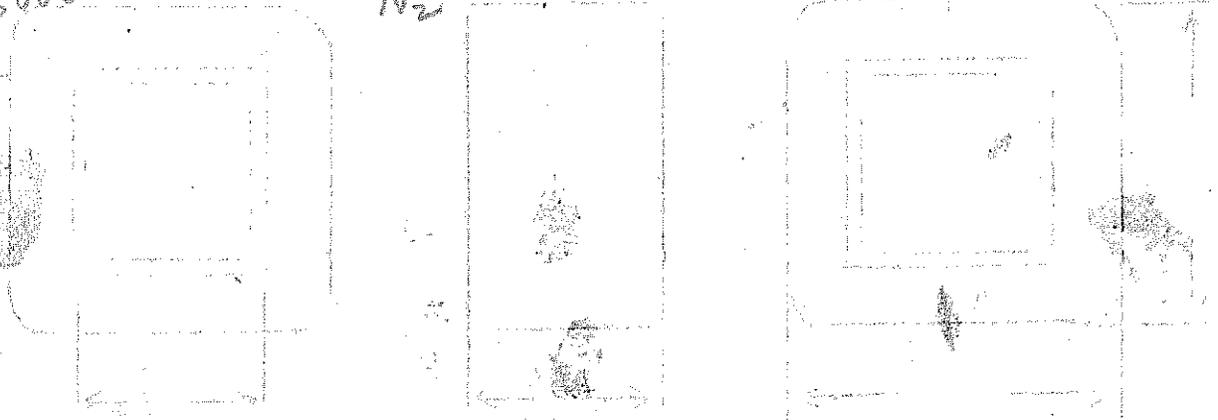

PP. 210 Class B to 5000 or 10000 Ω

Pri - 8000

sec - 200 MA - 5000V. Ins.

SPEC. NO. 1936

Winding	PRI	SEC				
Turns	3100	3400				
Taps	1550	2430				
Wind. Lgth.	15/8"	15/8"				
Wire Size	#32	#29				
T.P.L.	172-18	122-28				
Kind Term.	22 Braid placed by winders					
Term. Lgth.	5"	5"	5"			
Layer Insul.	double 16#					
Wrapper	2L007VC 3L007	2L007K 2L007GA				
TUBE	7L007+ 1L007VC		IMPREGNATION	VARNISH		
CURE	1/4" X 2 1/2"		Gap. 0.10" 26 Ga			

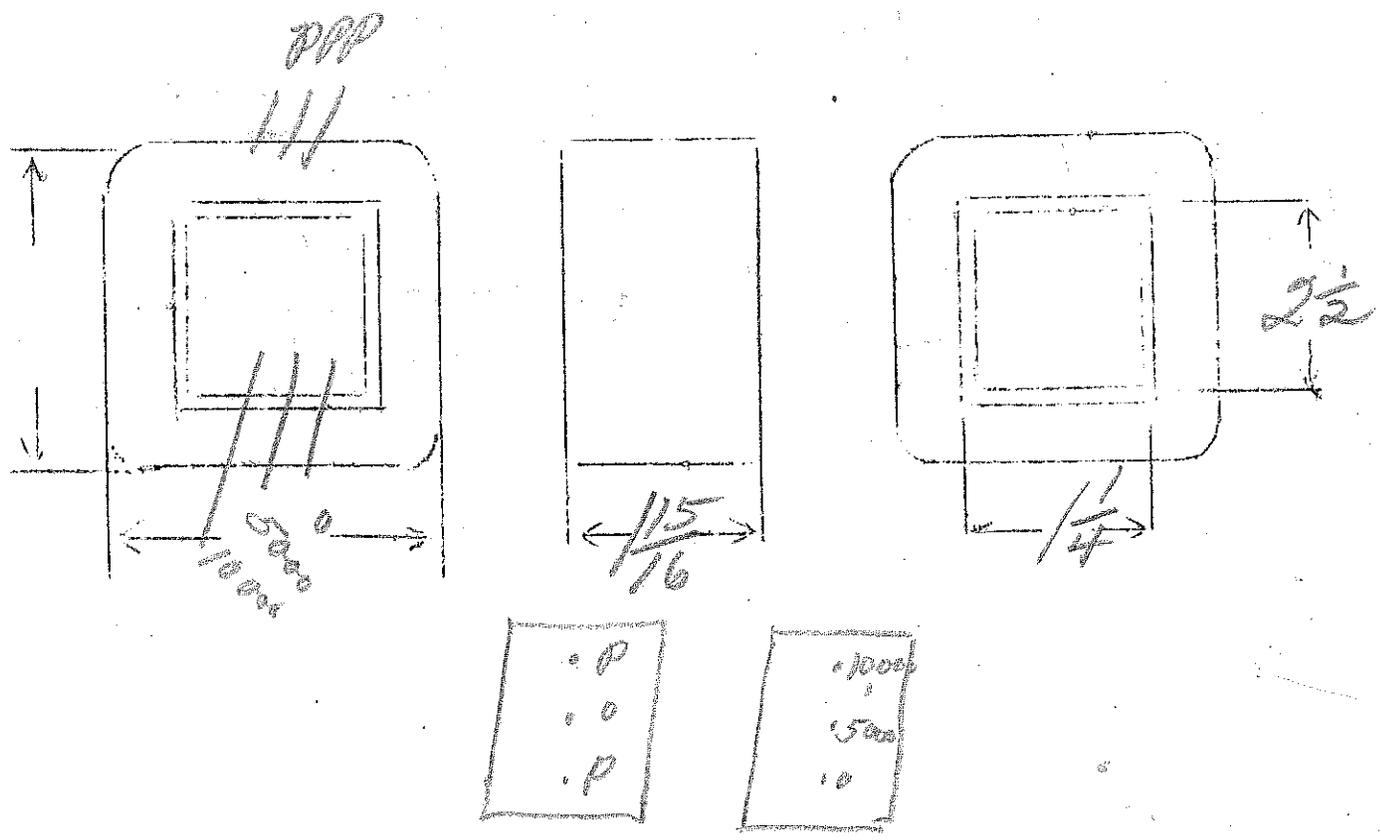

Special Therapy output transformer
 Parallel 2A3 to load.

SPEC. NO. 1971-C

Winding	PRI	SEC				
Turns	3460	2100				
Taps	1980	—				
Wind. Lgth.	1.25	1.25				
Wire Size	#34	#32				
T.P.L.	1165-24	132				
Kind Term.	#20 Per B					
Term. Lgth.	12" out of SA mtg.					
Layer Insul.	30#	30#				
Wrapper	2L007VC	2L005BA				
TUBE	7L007		IMPREGNATION	VARNISH		
CURE	1x1	26 Ma	Butt stack on top			

black
 P P black
 1/1

7mm
 5.5x1.67
 start
 red

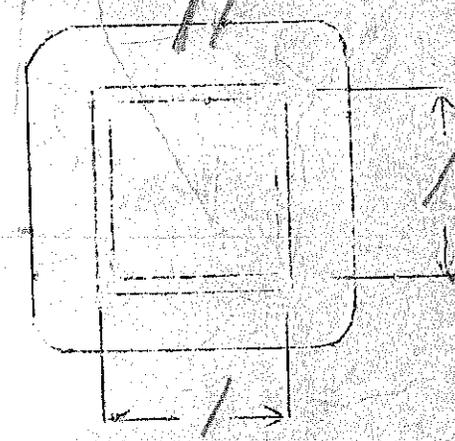
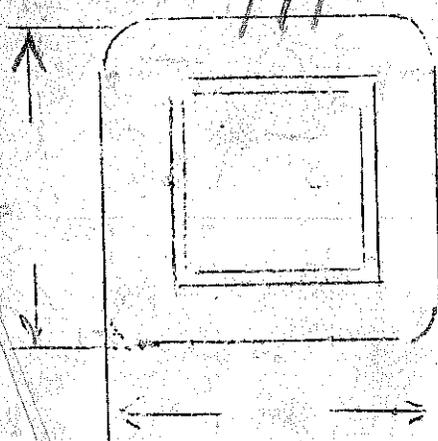

4000 Ω (43plate) to 2 Ω \approx VC

SPEC. NO. 1938

Winding	PRI	SEC				
Turns	3300	76				
Taps	-					
Wind. Lgth.	7/8					
Wire Size	#36	#21				
T.P.L.	143-24	3L				
Kind Term.	sil Br	WIRE ONLY				
Term. Lgth.	3	3				
Layer Insul.	20#	50#				
Wrapper	20056A	20056A				
TUBE	72007		IMPREGNATION		VARNISH	
CURE	3/4 x 1	29 Ga	Temp. 005			

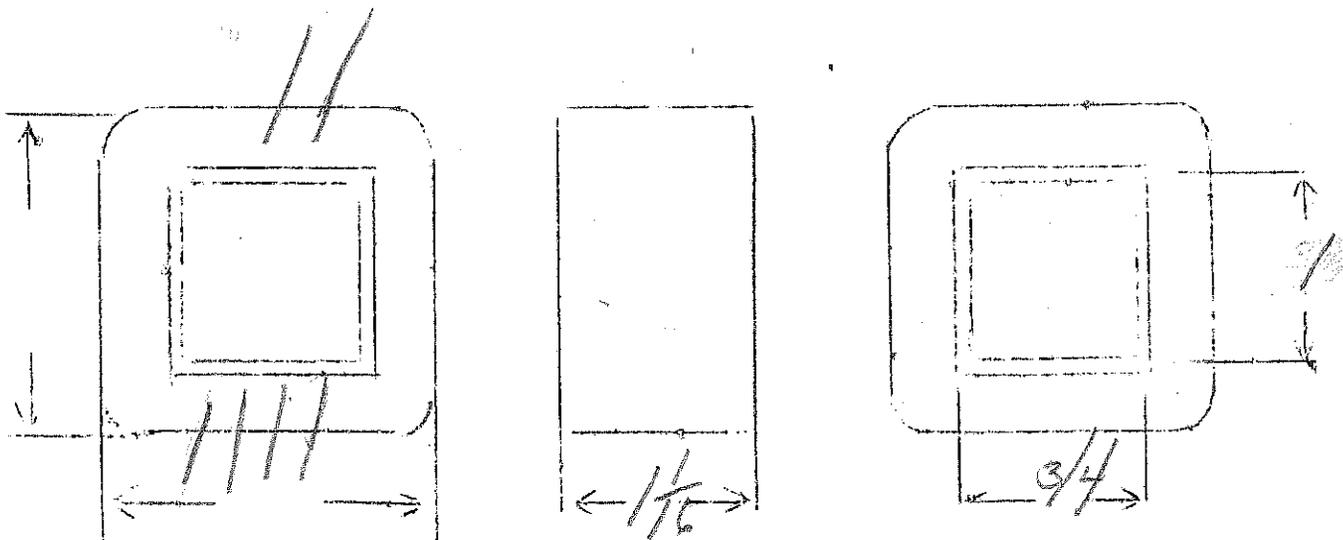

40-200 Ω

$\pm 20\%$ 30-10,000 Ω

SPEC. NO. 1939

Winding	PRI	SEC	PRI				
Turns	175	800	175				
Taps	-	-	-				
Wind. Lgth.	1.25	1.25					
Wire Size	#25	#28	#25				
T.P.L.	59-3	81-10	59-3				
Kind Term.	WIRE ONLY						
Term. Lgth.	4"	4"					
Layer Insul.	40#	40#	40#				
Wrapper	7L005VA 6LAL	7L005VA 6LAL	7L005GA				
TUBE	7L007		IMPREGNATION	VARNISH			
CURE	1 x 7/8		272	29.5 A Grade Under			

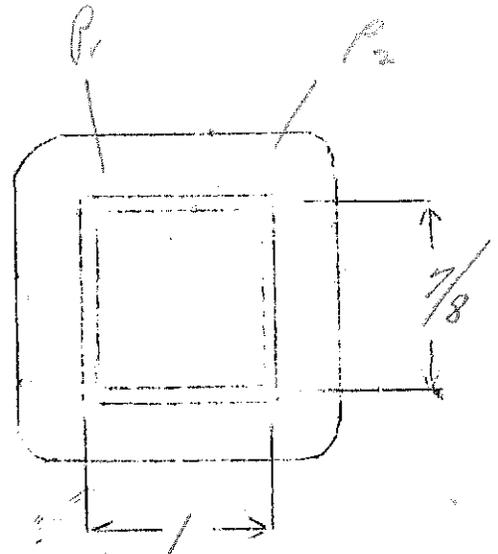
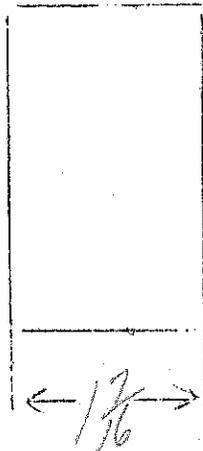
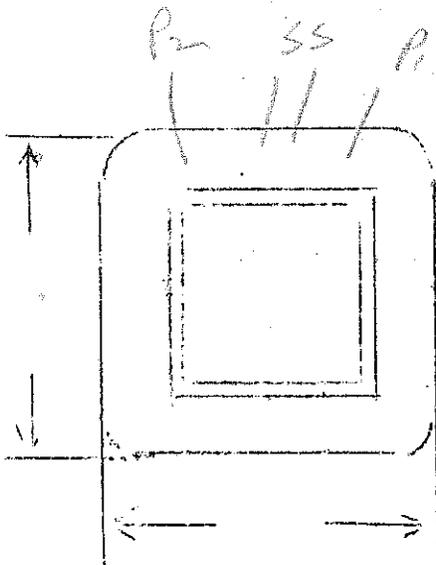

OK 1982

$$\frac{200}{40} = 5$$

$$\frac{N_1}{N_2} = 2.24$$

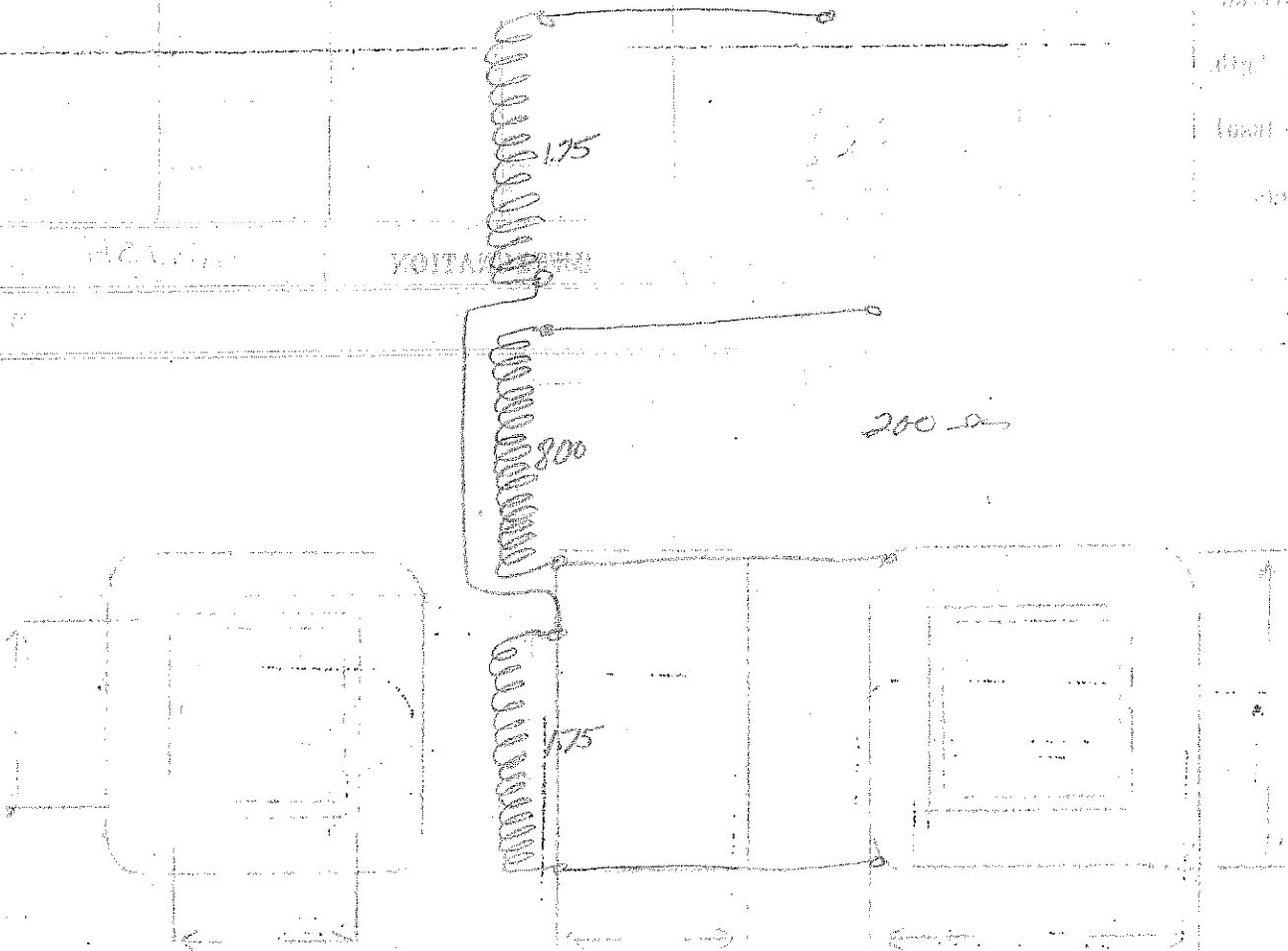

6A6 single section (20000)
to 20000

SPEC. NO. 1940

Winding	PR1	SEC					
Turns	5000	1600					
Taps	✓						
Wind. Lgth.	7/8	7/8					
Wire Size	#38	#34					
T.P.L.	180-28	115-40					
Kind Term.	silver	silver					
Term. Lgth.	3"	3"					
Layer Insul.	16#						
Wrapper	120076	240058A					
TUBE	42007			IMPREGNATION			WAT
CURE	3/4 3/4			Butt. stack no gap			

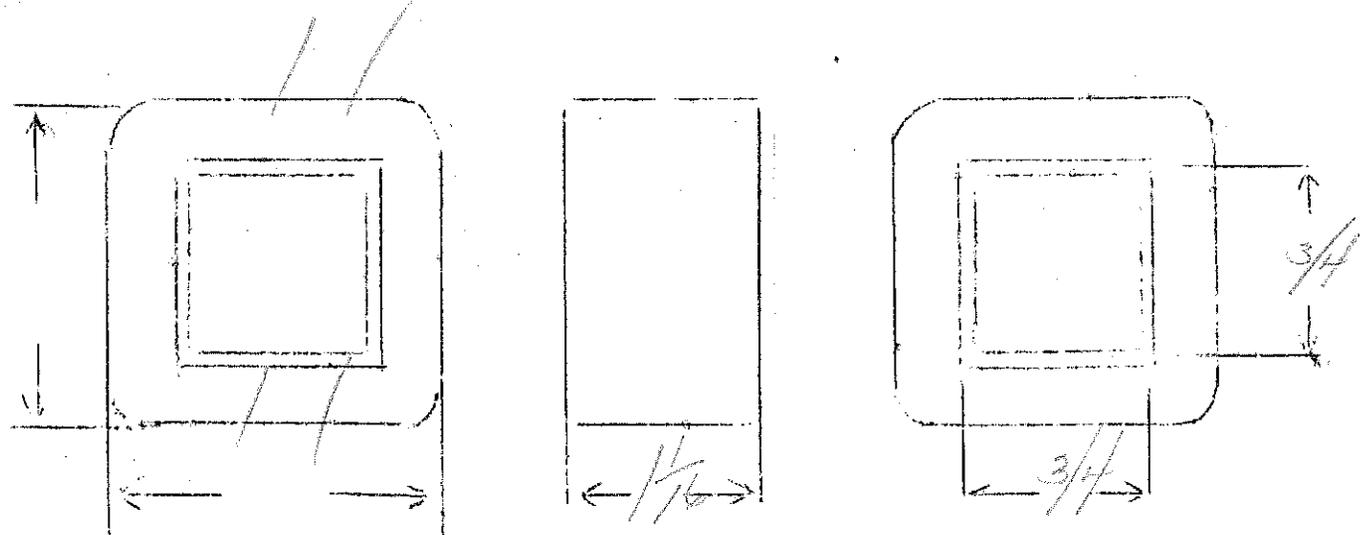
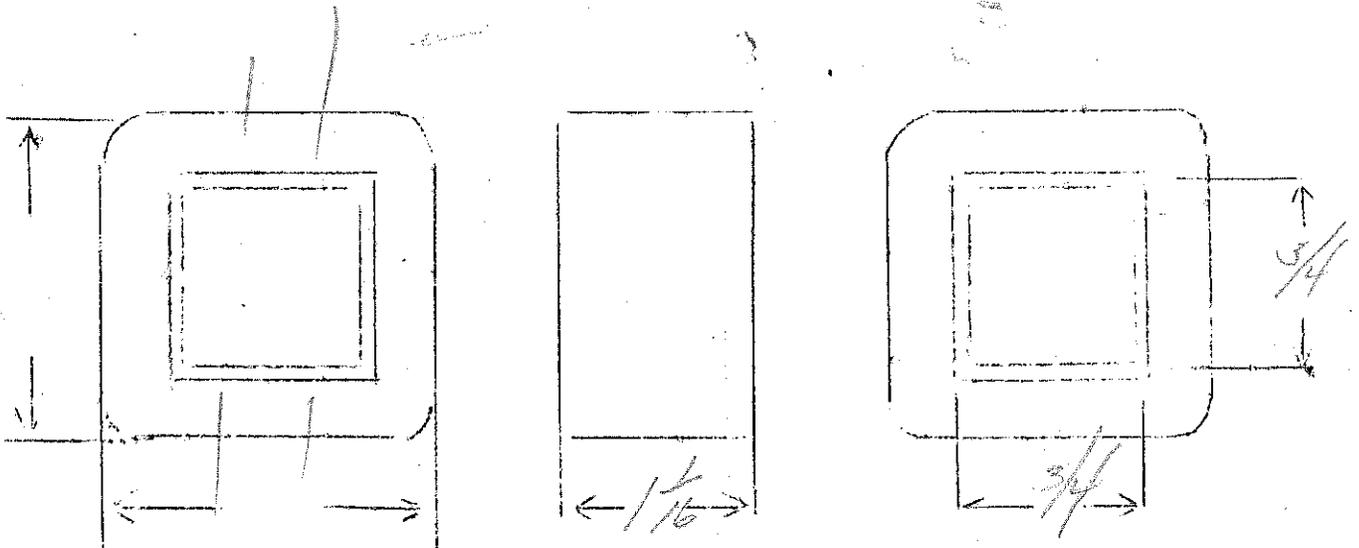

Plate of 205 or 42 to 5 ohm r.c.

275

SPEC. NO. 1941

Winding	PR1	SEC				
Turns	3300	88				
Taps						
Wind. Lgth.	7/8	7/8				
Wire Size	#36	#21				
T.P.L.	145-23	42				
Kind Term.	22 Braid	WIRE ONLY				
Term. Lgth.	3	3				
Layer Insul.	20#					
Wrapper	21005GA	21005BA				
TUBE	4407		IMPREGNATION		VARNISH	
CURE	3/4 X 3/4		003" gap			



5.2 to grid

SPEC. NO. 1942

Winding	SEC	PRI				
Turns	8400	59				
Taps	—	—				
Wind. Lgth.	15/16	15/16				
Wire Size	#40	#21				
T.P.L.	236-36	3L				
Kind Term.	fil Braed	WIRE ONLY				
Term. Lgth.	3"	3"				
Layer Insul.	16#					
Wrapper	21005GA	21005GA				
TUBE	72007		IMPREGNATION		WAX	
CURE	3/4 V 3/4	3 x 2	20.008			

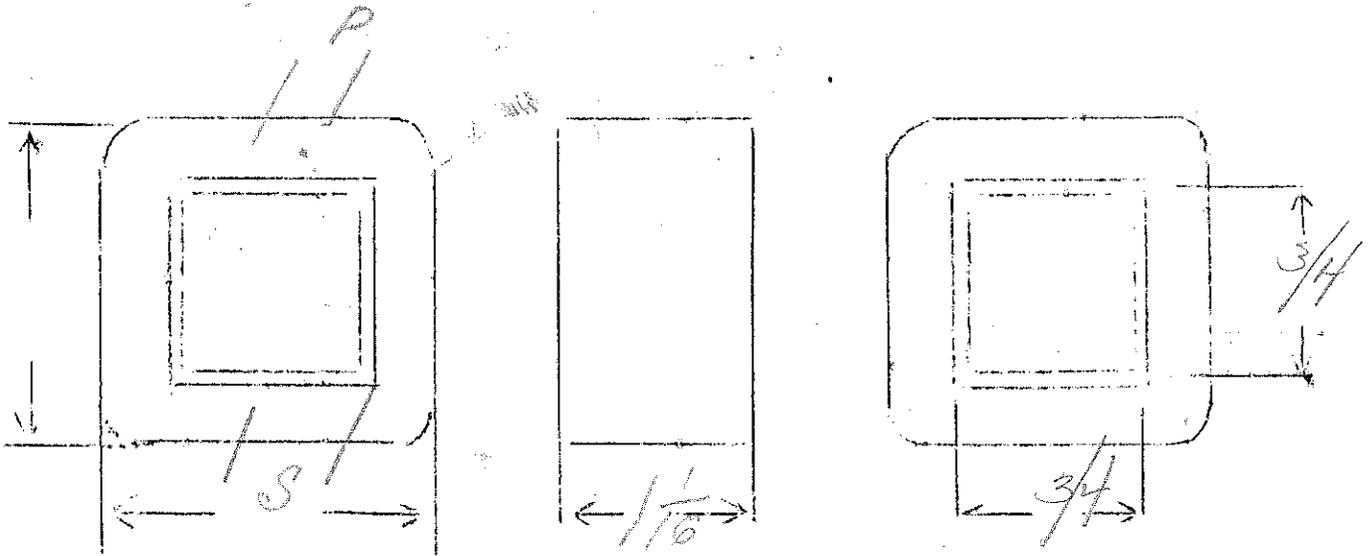

Single H to 2.0 wire coil.
 7600 to 2.0 6/16

SPEC. NO. 1943

Winding	PRI	SEC				
Turns	4000	68				
Taps	—	—				
Wind. Lgth.	1 1/6	1 1/6				
Wire Size	#36	#20				
T.P.L.	170-24					
Kind Term.	SLB	WIRE ONLY				
Term. Lgth.	3"	3"				
Layer Insul.	30#					
Wrapper	2L003GA	2L005GA				
TUBE	7L007	IMPREGNATION		VARNISH		
CURE	7/8 x 7/8	.005" Gap				

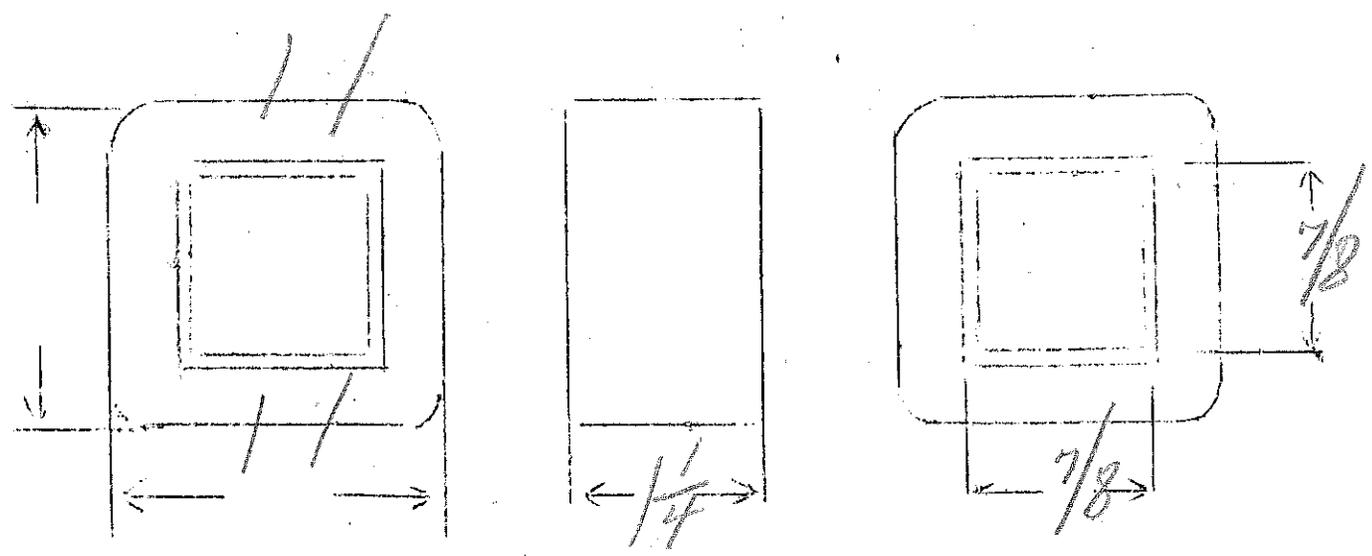

PP, Class B 03A plates to 2500 or 10,000 - 200 or 4000
 (9000 P.P.)

Sec - 7500V breakdown
 Pri - 5000V to ground
 SPEC. NO. 1944

Winding	PRI	SEC				
Turns	2700	2860				
Taps	—	—				
Wind. Lgth.	1 5/8	1 5/8				
Wire Size	#28	#28				
T.P.L.	108-26	110-26				
Kind Term.	WIRE	ONLY				
Term. Lgth.	4"	4"				
Layer Insul.	40#	40#				
Wrapper	31007VC	31007VC 31005GA				
TUBE	102007 + 14007VC		IMPREGNATION	VARNISH		
CURE	2x2 - Butyl stack - 010" gap					

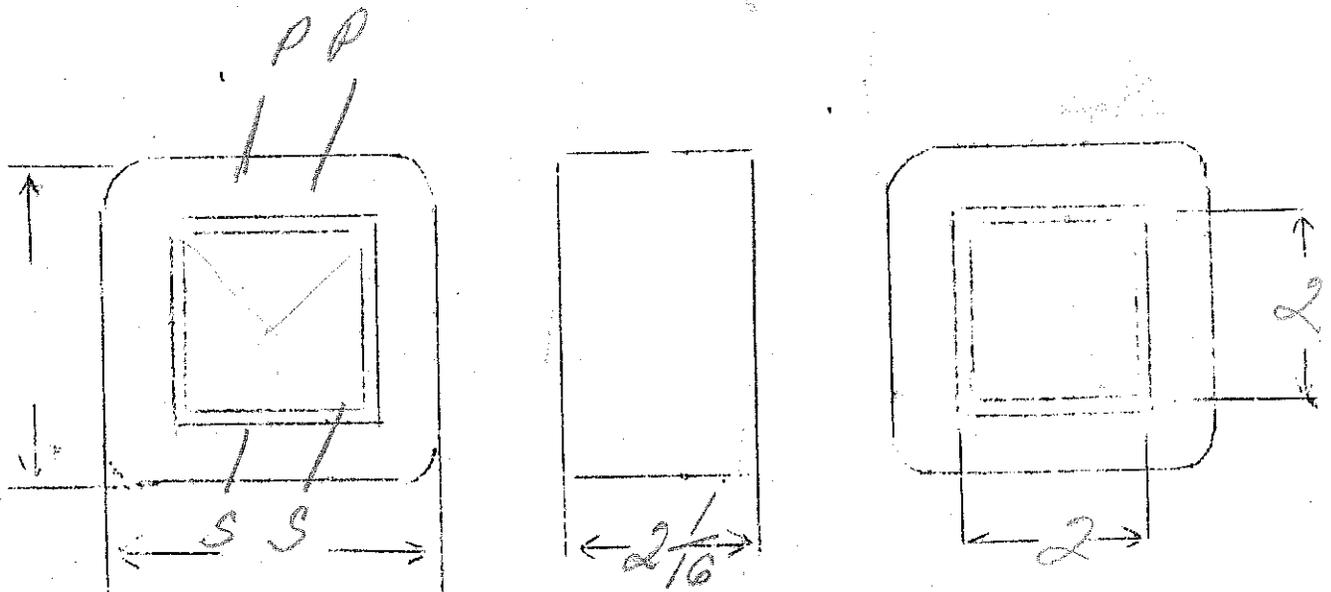

REVERSE ASSEMBLY - J mty

$$\frac{9000}{2500} = 3.6 \quad \frac{N_1}{N_2} = 1.9$$

$$\frac{N_{1/2P}}{N_{1/2S}} = 9.5$$

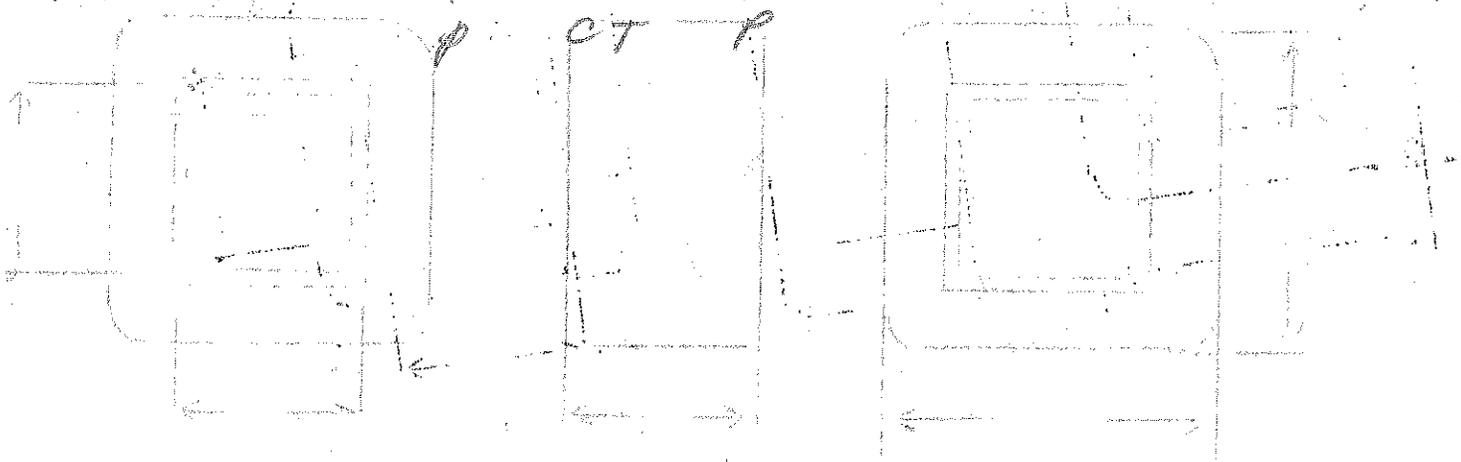
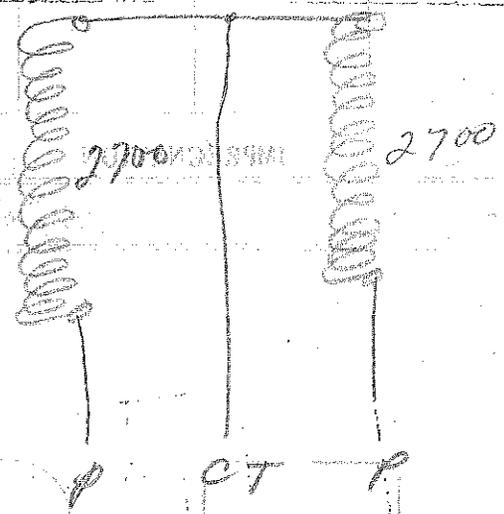
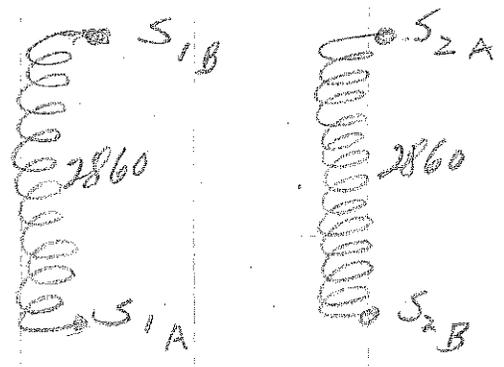

Pri - 500, 250, 166 Ω to 2.2, 5, 7.5, 15 Ω
 5 watts each

Continuous

SPEC. NO. 1945

Winding	PRI	SEC				
Turns	800	54	36			
Taps	560 480		26-46			
Wind. Lgth.	1 1/6	1 1/6	1 1/6			
Wire Size	#29	#20	#23			
T.P.L.	80-10	24	32			
Kind Term.	Al Br	WIRE ONLY				
Term. Lgth.	3"	3"	3"			
Layer Insul.	30#	50#				
Wrapper	210056A		210056A			
TUBE	7L007			IMPREGNATION		VARNISH
CURE	7/8 x 7/8		2x2			

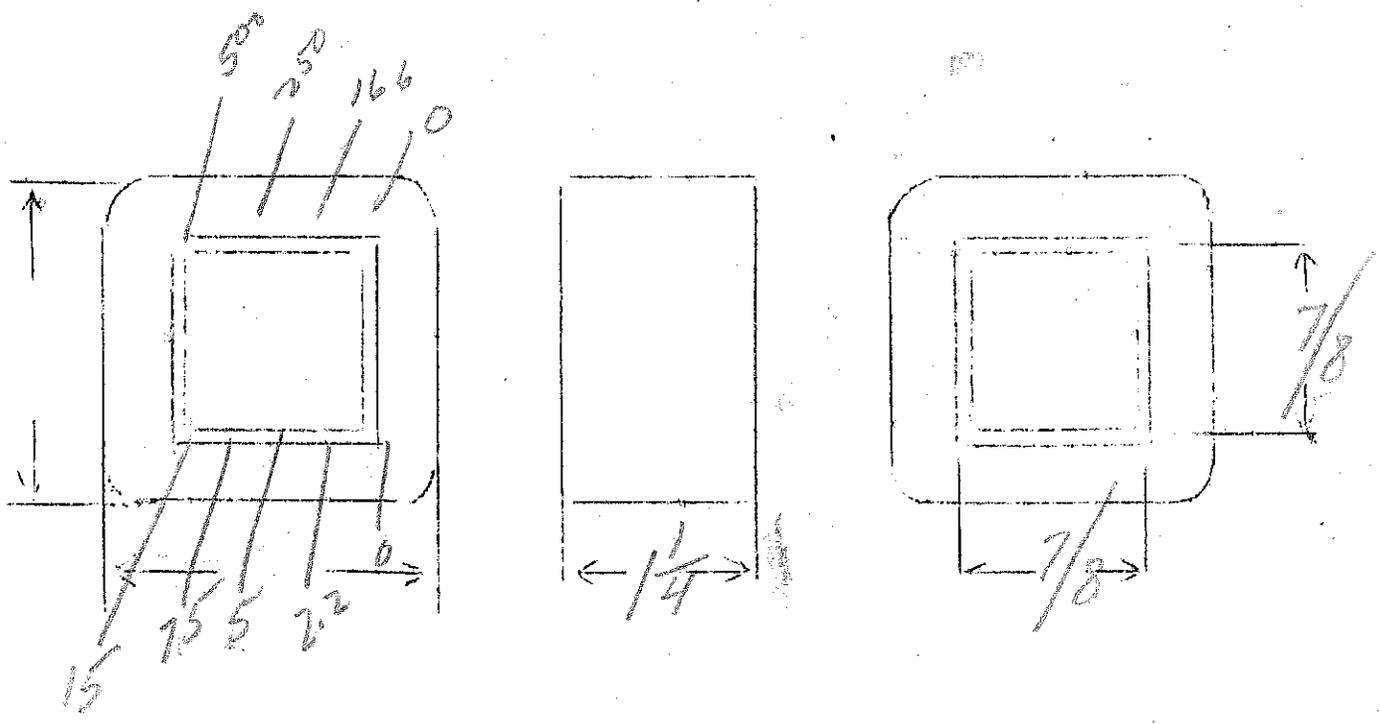

10000 Ω pt (50) to 200 or 50 Ω

71

SPEC. NO. 1946

Winding	PRI	SEC					
Turns	4000	560					
Taps	—	280					
Wind. Lgth.	3/4	3/4					
Wire Size	#39	#32-					
T.P.L.	170-24	71-8					
Kind Term.	silver	brnd					
Term. Lgth.	3"	3"					
Layer Insul.	16#	30#					
Wrapper	12007VC	2L0056A					
TUBE	7L007			IMPREGNATION		VARNISH	
CURE	6X6	2X2					

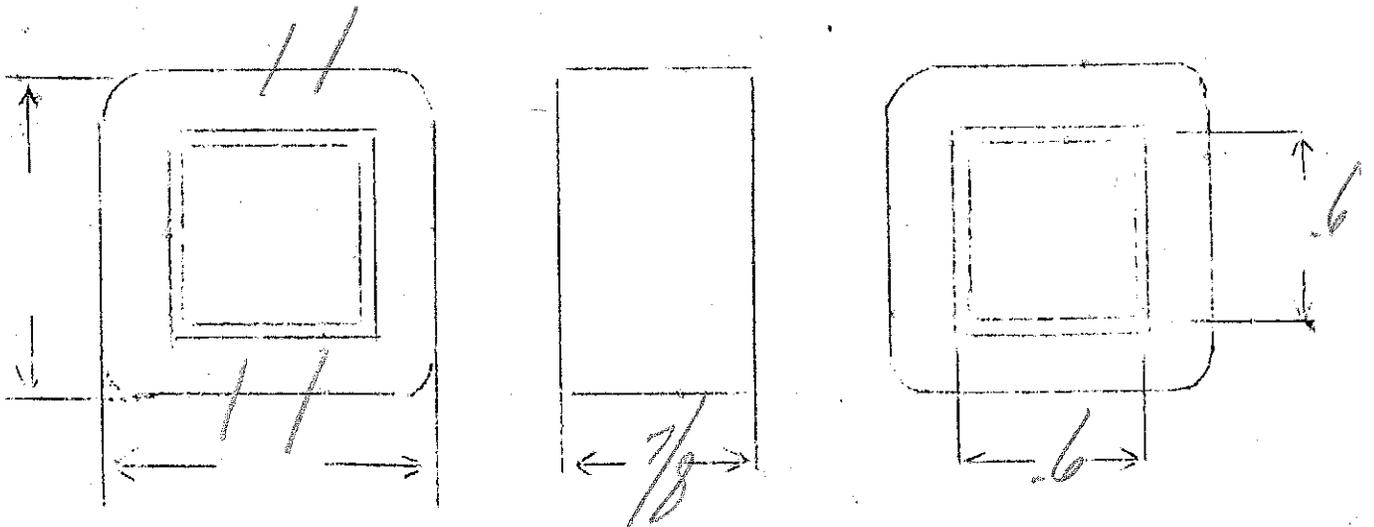

PR1 - Class B P.P. 210 transformer

4500, 6500, 8000, 11000

SPEC. NO. 1947

Continuation

Winding	PR1	SEC				Sec 2
Turns	3400	2680	2040			265
Taps	1700		340-680-1360			
Wind. Lgth.	$\frac{15}{8}$	$\frac{15}{8}$				
Wire Size	#32	#31	#32			#36
T.P.L.	170-20	150-18	170-12			
Kind Term.	sil Br	placed by winders				
Term. Lgth.	5"					
Layer Insul.	double 16"	double 16"				
Wrapper	21007VC 3198		21007VC 21007GA			21007GA
TUBE	71007-11007VC		IMPREGNATION		VARNISH	
CURE	1/4 x 2		gap - .015 26 Ga			

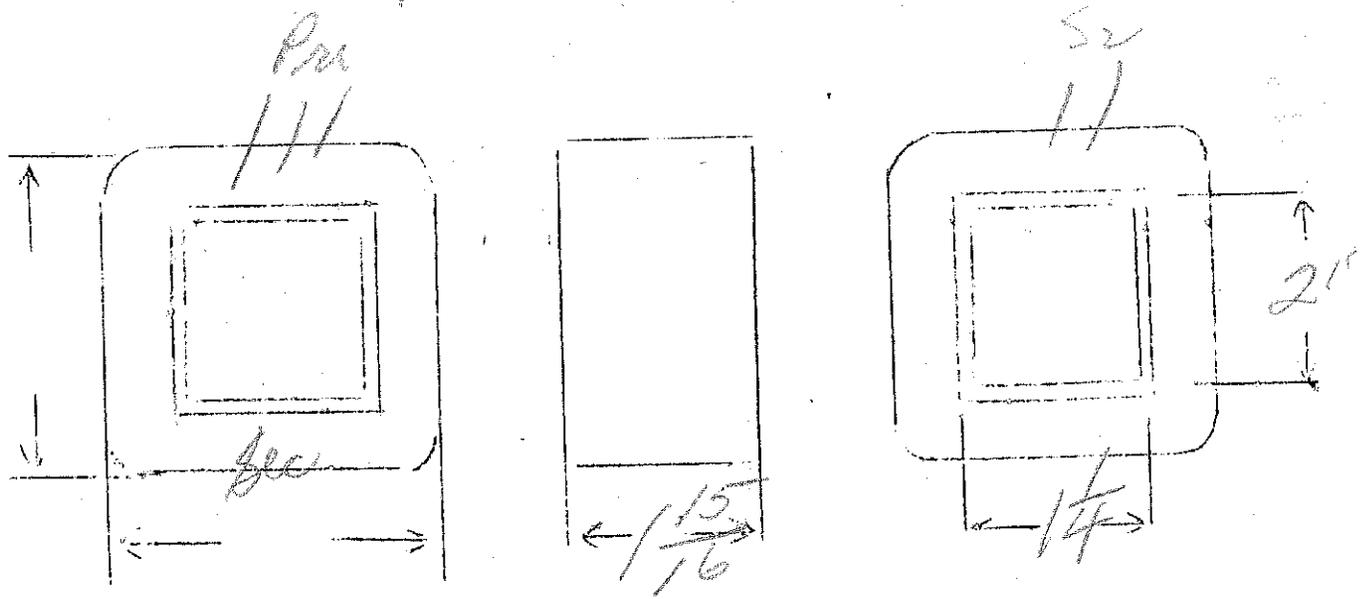

PP Par Connected (2 tube) 53

to deliver 110V to patient at 15 watts

at 2000 cycles only

(1000) leaved Sec
6.000

26
2.25

SPEC. NO. 1942

Winding	PRI	SEC					
Turns	2400	1200 1100					
Taps	1200	600-100					
Wind. Lgth.	$\frac{1.15}{.32}$	$\frac{1.15}{.32}$					
Wire Size	# 31	# 29					
T.P.L.	134-18	110					
Kind Term.	# 20 strand						
Term. Lgth.	9"	9"					
Layer Insul.	40#	40#					
Wrapper	1007VC	21005SA					
TUBE	71007		IMPREGNATION			VARNISH	
CURE	1 hr @ 170		2x2 26 Ga				

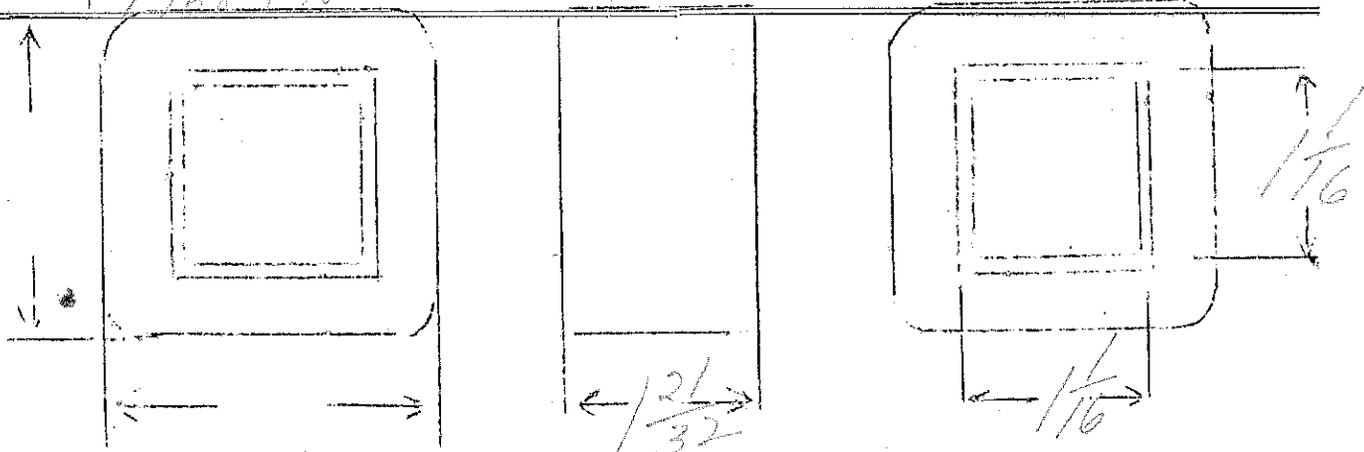

lead positions not critical

P.P. Par 2AS trade converted AB.
 to 3-6-9 15-500 d v e
 30 wats - 4000 r p r

SPEC. NO. 1949

Continued

Winding	PRI	SEC				
Turns	3100	950	73	38	88	
Taps	1550	—	45	—	—	
Wind. Lgth.	$\frac{15}{32}$	$\frac{15}{32}$	$\frac{15}{32}$	$\frac{15}{32}$	$\frac{15}{32}$	
Wire Size	33	29	22	21	19	
T.P.L.	173-18					
Kind Term.	SL Br	SL Br	WIPE	ONLY		
Term. Lgth.	4"	4"	4"	4"	4"	
Layer Insul.	30#	30#		50#		
Wrapper	2L007V1				2L005GA	
TUBE	7L007			IMPREGNATION	VARNISH	
CURE	$\frac{1}{16} \times \frac{15}{8}$		$\frac{1}{2} - 29 \text{ hrs}$	$\frac{1}{2} - 26 \text{ hrs}$	2x2	

end of sec is start 0"

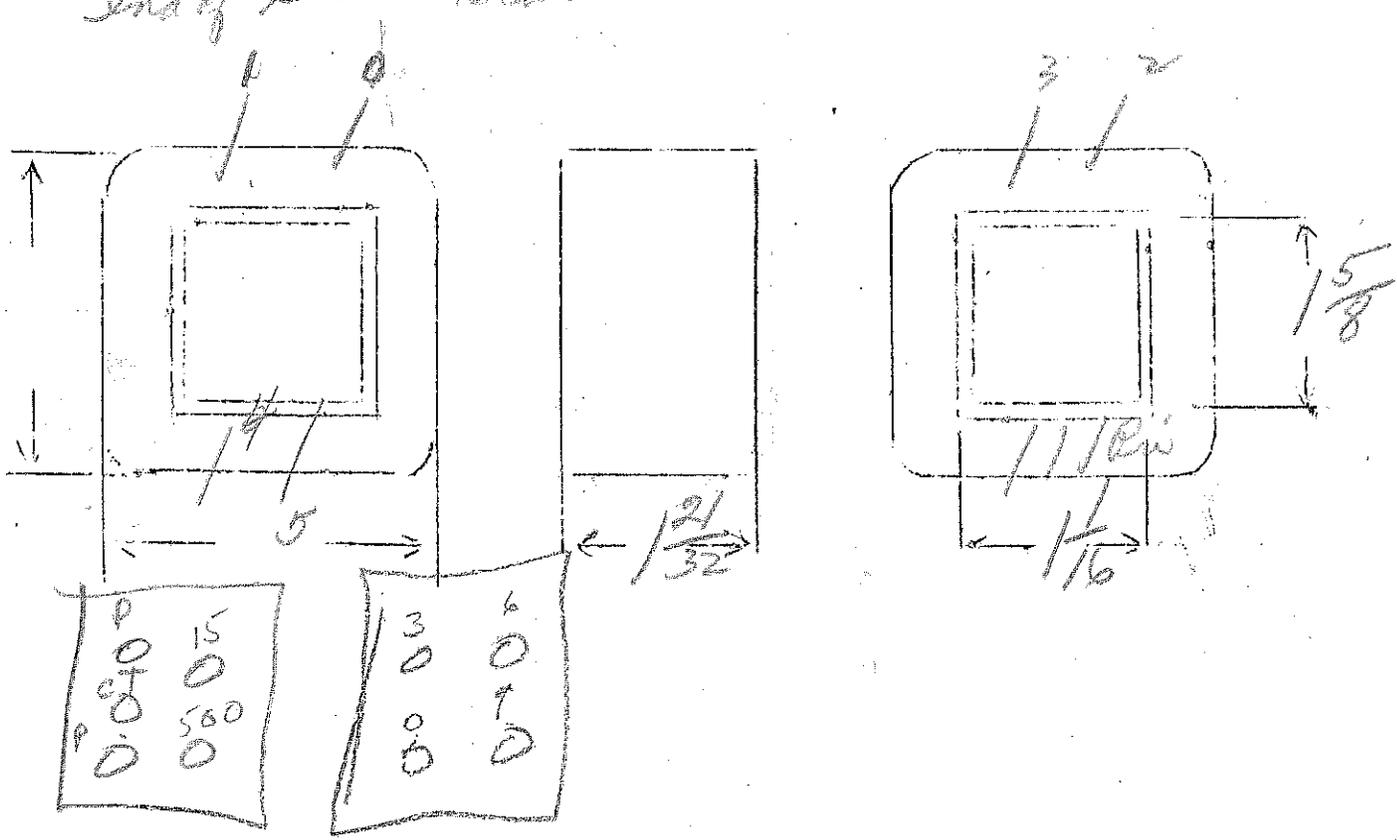

on a 1 turn basis

3 - 1.732

6 - 2.45

9 - 3.0

15 - 3.88

300 - 22.4

4000 - 63.2

P.	0
CS	0
P.	5050

30	06
0	09
0	1

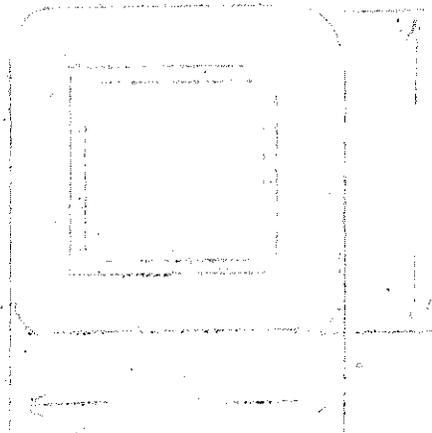
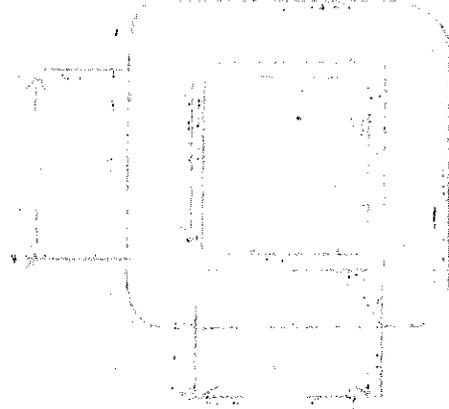

PRI - 7000 Ω or 10,000 P.P - 500 watts at 2000V at 1000

SEC - 5000 - 6600 - 8300 - 10,000 - 500 ma

SPEC. NO. 1950

Winding	PRI	SEC				
Turns	1250	2620				
Taps	1050	1860 - 2130 - 2400				
Wind. Lgth.	1 1/2"	3 1/2"				
Wire Size	#25	#23				
T.P.L.	70-18	133-20				
Kind Term.	#25	WIRE ONLY				
Term. Lgth.	6"	6"				
Layer Insul.	double 40H	double 40H				
Wrapper	41005VC 51007VC	62007VC 31005CA				
TUBE	10L007-4/1007VC		IMPREGNATION	VARNISH		
CURE	2 x 3 1/2	- gap .020				

2 pri - 1250 each

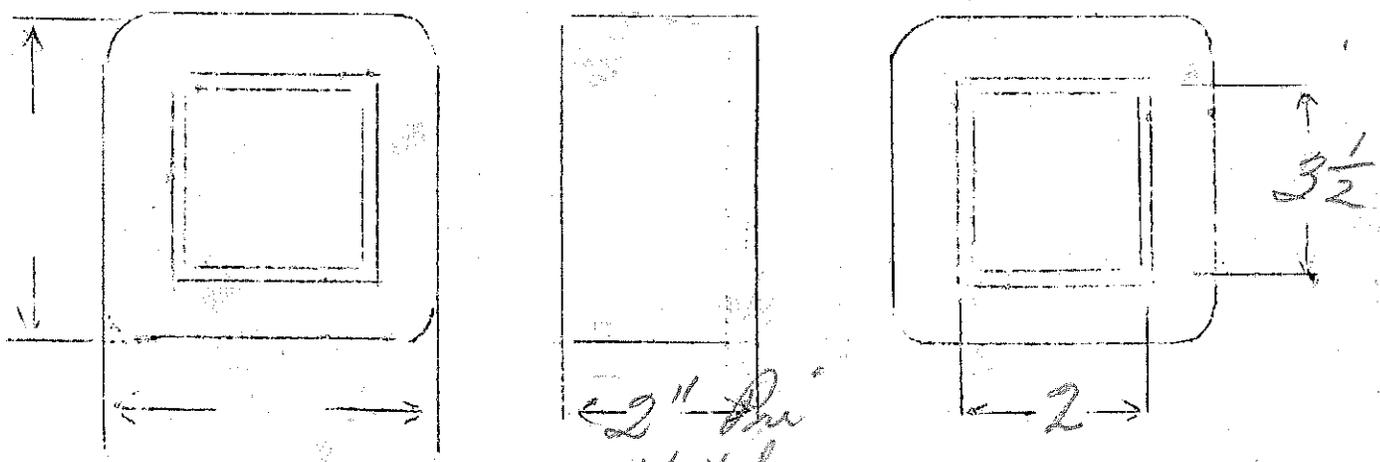

2" Pri
4 1/4" Sec

10000 530
5000 480

on a turn basis

- 7000 - 835
- 7000 - 100
- 5000 - 71.
- 6600 - 81.
- 8300 - 91
- 10,000 - 100.

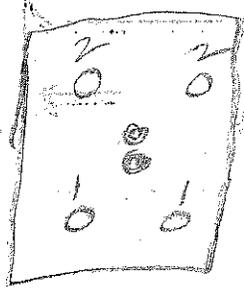
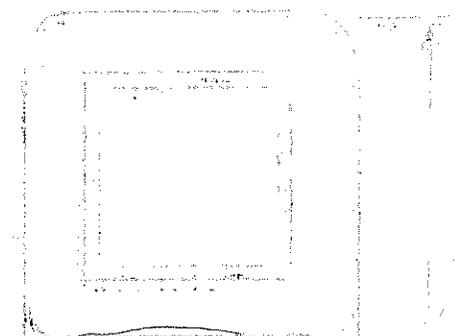
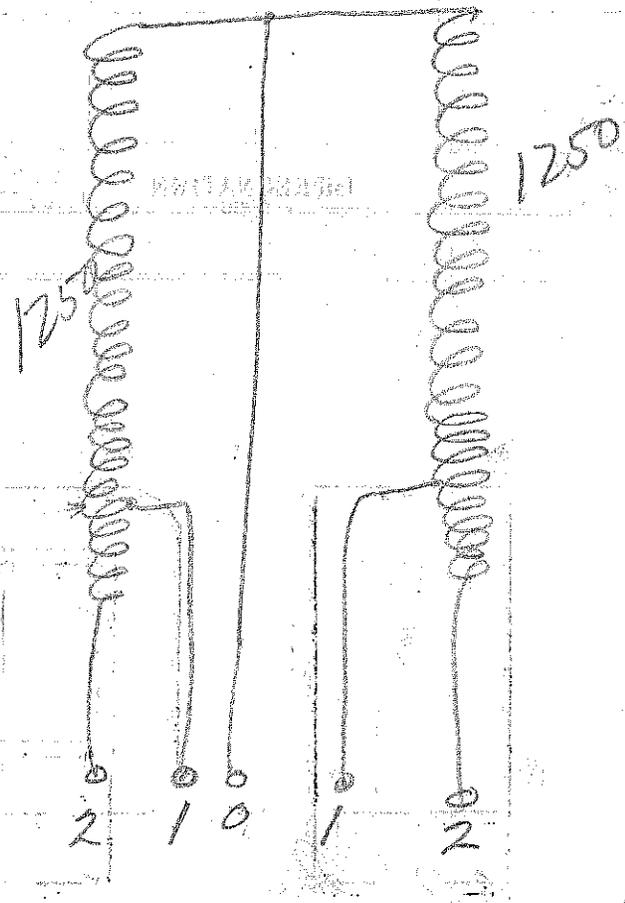
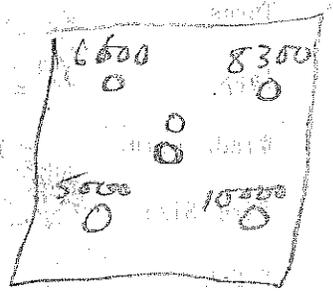
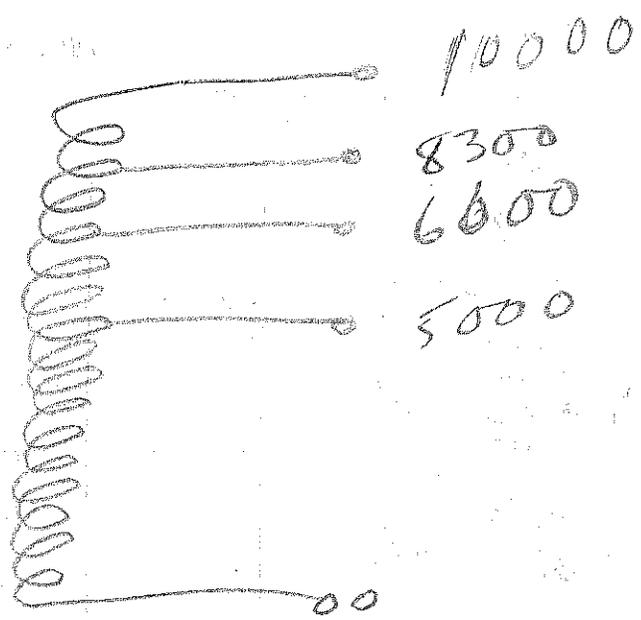

Parallel 47 to VC - 15 Ω VC

ratio 158

SPEC. NO. 1951

Winding	PRI	SEC					
Turns	3100	200					
Taps	—	150					
Wind. Lgth.	1 1/16	1 1/16					
Wire Size	#34	#23					
T.P.L.	141-22	40-5					
Kind Term.	Sil B ₂	W.O.					
Term. Lgth.	3"	3"					
Layer Insul.	30#	50#					
Wrapper	210056A	210056A					
TUBE	42007		IMPREGNATION		VARNISH		
CURE	7/8 x 7/8		Gap. 005				

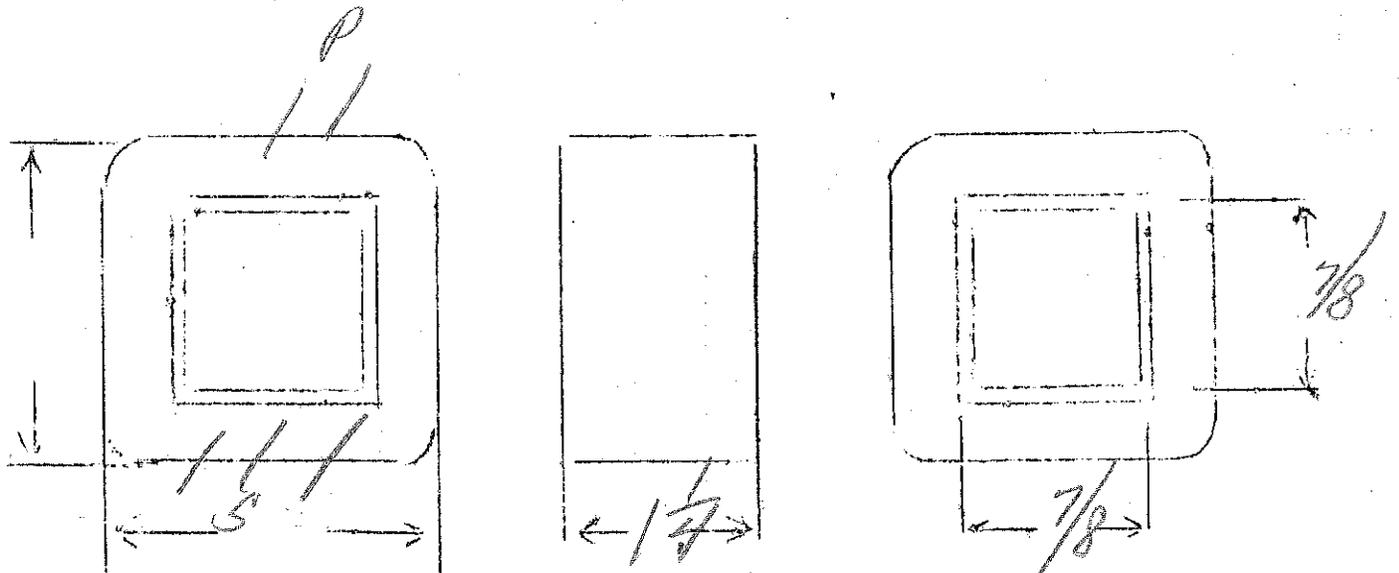

14000.2 to 1.8 r.v.c.

SPEC. NO. 1952

2.92V 1.36

Winding	PRI	SEC				
Turns	2200	52				
Taps	—	—				
Wind. Lgth.	3/8	7/8				
Wire Size	#37	#21				
T.P.L.	69-32	24				
Kind Term.	#20 P.Braid	WIRE ONLY				
Term. Lgth.	4"	4"				
Layer Insul.	20#	—				
Wrapper	2L0056A	2L0056A				
TUBE	4L007		IMPREGNATION	VARNISH		
CURE	3/4X1	annealed 296s 2X2				

2 pri windings reverse assembly

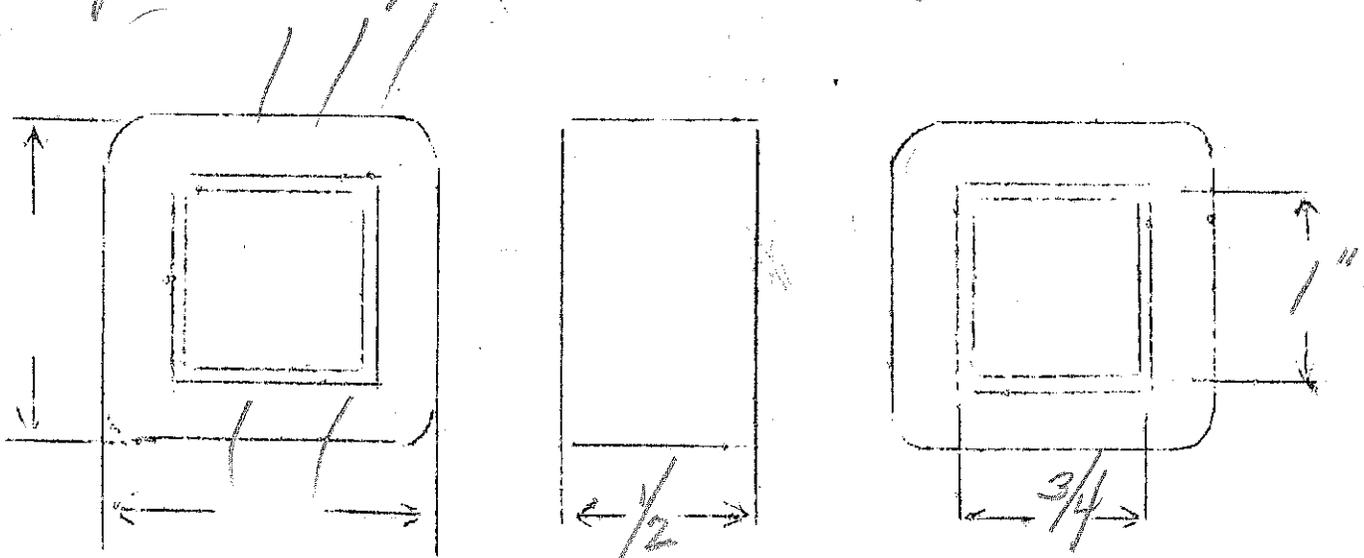

$$\frac{14000}{1.8} = 7700$$

$$\frac{N_1}{N_2} = 86$$

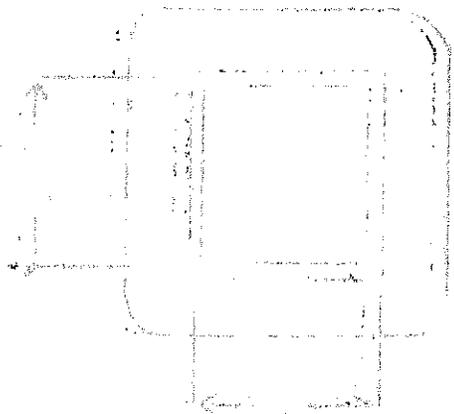
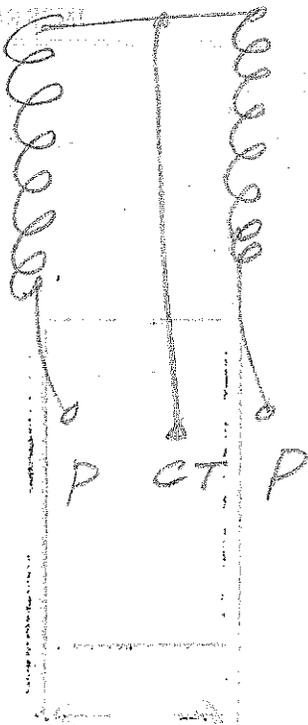
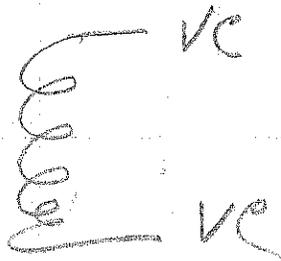

8000 or 14000 Ω to two windings tapped as shown

375
283
188
14

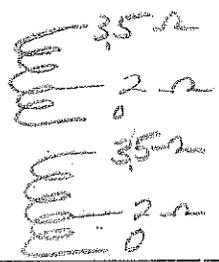

16, 8, 4, 2

(test purposes only)

SPEC. NO. 1953 unrec'd

Winding	PRI	SEC ₁	SEC ₂				
Turns	2500	120	120				
Taps	1910	93	93				
Wind. Lgth.	9/16	1/4	1/4				
Wire Size	35	#23	#23				
T.P.L.	83-36	54					
Kind Term.	Sil/Bu	WIRE ONLY					
Term. Lgth.	3"	3"	3"				
Layer Insul.	30#	40#					
Wrapper	21056A	21056A					
TUBE	72007	IMPREGNATION		VARNISH			
CURE	1x1 annealed 2900 2x2						

Pri 2 windings

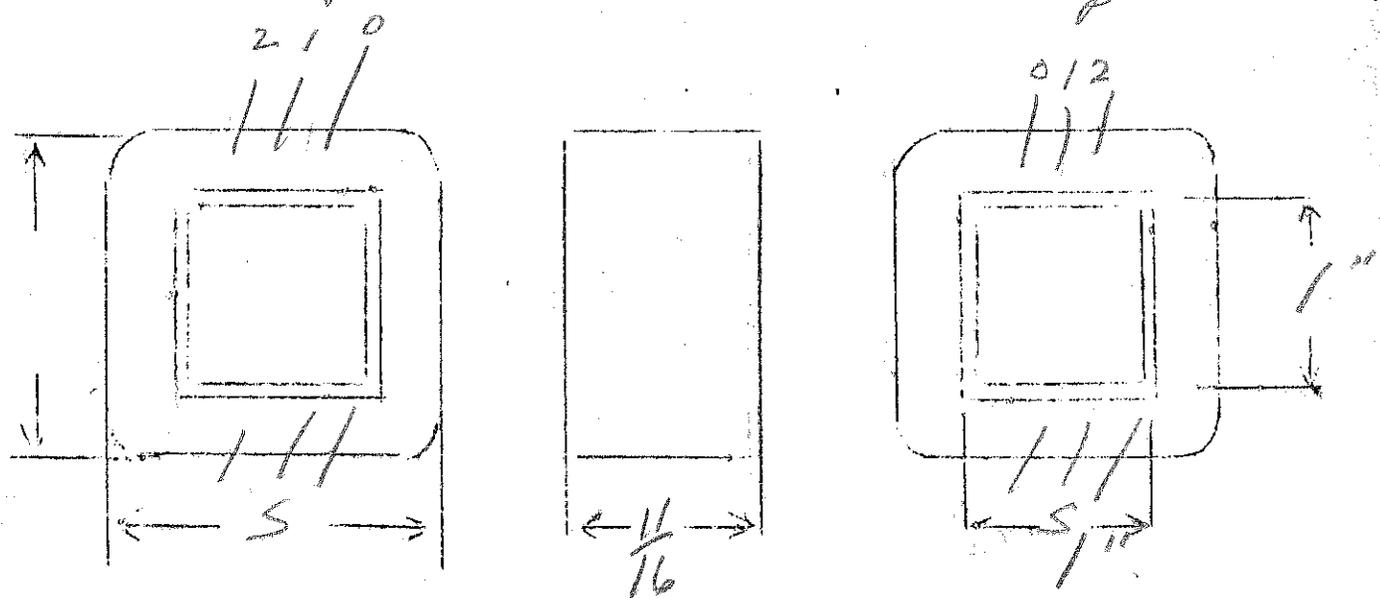

Frequency Characteristics
Flat ± 3 db 30-5000 \sim

P.P. input choke

PIERSON - DELANE

30

SPEC. NO.

1954

Winding	PRI	SEC				
Turns	6250	6250				
Taps			P.P.	White		
Wind. Lgth.	7/8	7/8		Black		
Wire Size	#39	#39	Sec	Red		
T.P.L.	200	200		Blue		
Kind Term.	1/2" Braid					
Term. Lgth.	3"	3"				
Layer Insul.	1/6"					
Wrapper	W005VP	20056A				
TUBE	7007 HL 003VP		IMPREGNATION		WAX - Jam + Oil	
CURE	3/4 x 3/4. 20 Min. unrolled Audio A brace 2x2 3/4					

wind two coils - Bracket for leads shown

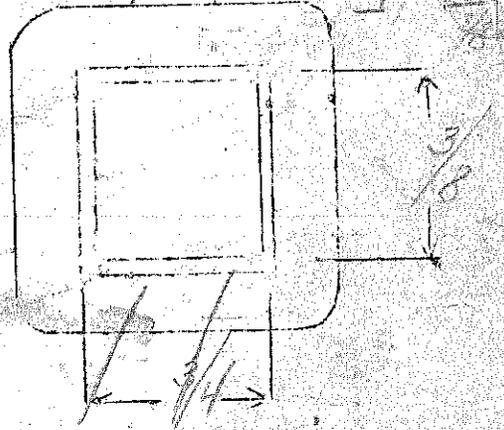
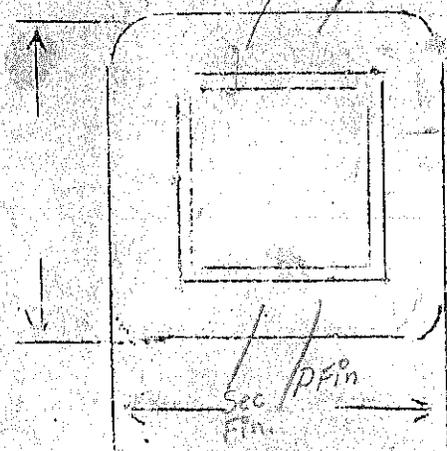

over

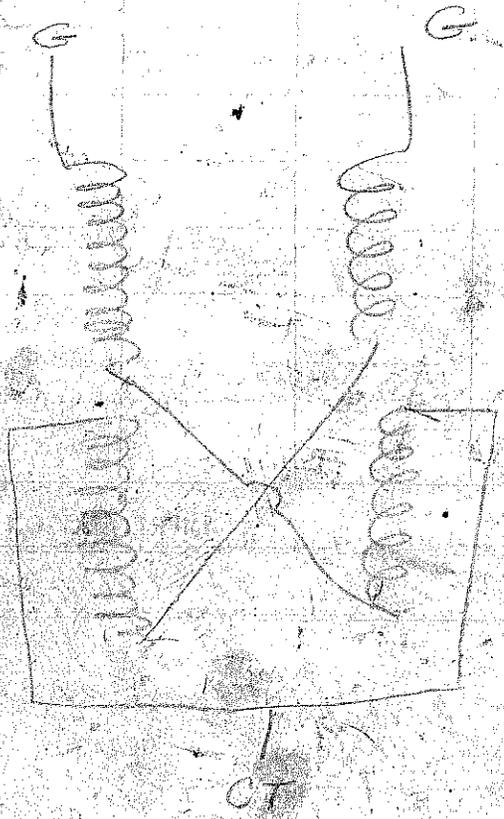
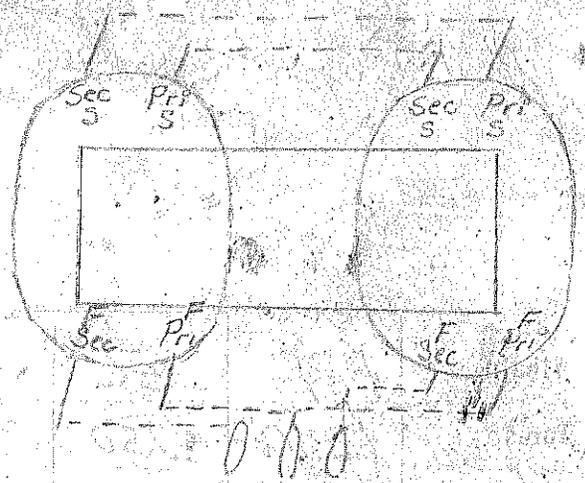

2-6AL class B to mod

Pri - 5000 Ω P-P
 Sec 1 - 5000 Ω - 100mA
 Sec 2 - 5000 Ω - 50mA

SPEC. NO. 1955

Winding	PRI Black Wired	SEC Red	SEC Blue			
Turns	3600	3600	3600			
Taps	1800	-				
Wind. Lgth.	1.75	1.75	1.75			
Wire Size	#32	#32	#24			
T.P.L.	183-20	183-20	226-16			
Kind Term.	#20 Brand					
Term. Lgth.	9"	9"	9"			
Layer Insul.	30#	30#	30#			
Wrapper	21007VC	21007VC	11007VC 210056A			
TUBE	71007 + 11007VC		IMPREGNATION	VARNISH		
CURE	1 1/4 X 1	1/2 29.20	1/2 26.60	Exp. 0.00		

use heavy finishing - .020 VC
 .007 GA

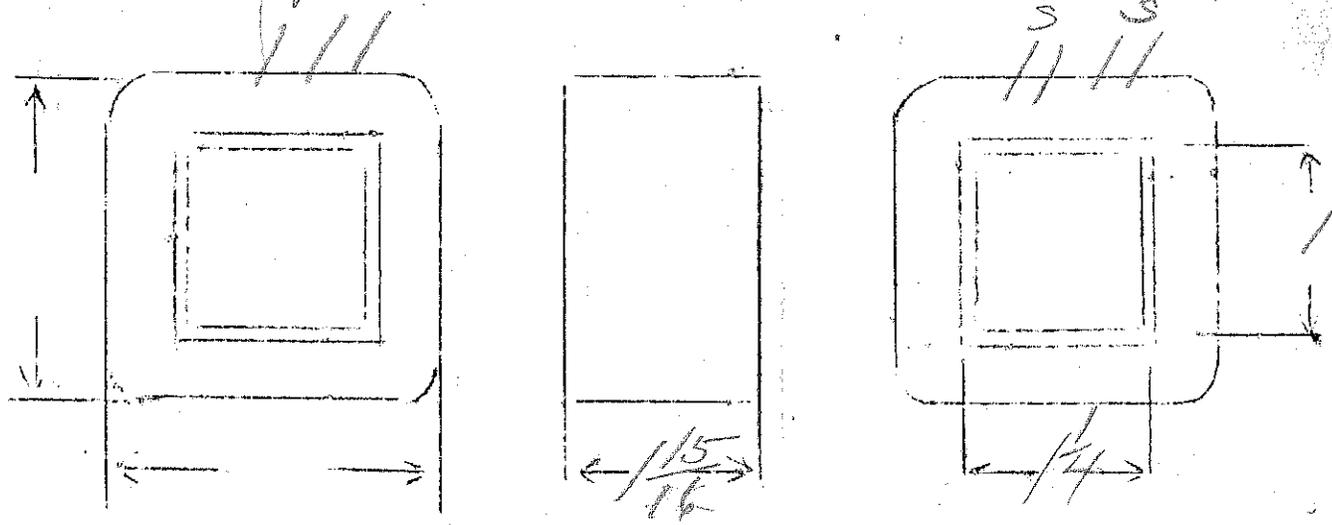

PP output choke

SPEC. NO. 1957

Winding	PRI	SEC				
Turns	5600	5600				
Taps	—	—				
Wind. Lgth.	3/4	3/4				
Wire Size	#40	#40				
T.P.L.	215-26	215-26				
Kind Term.	32 Braid					
Term. Lgth.	4"	4"				
Layer Insul.	12#	12#				
Wrapper	2005VP	20056A				
TUBE	52007+10013VP		IMPREGNATION	WAX - form & coil		
CURE	.6 x .6 annealed 29.60 2x2					

wind two coils - spiral bracket

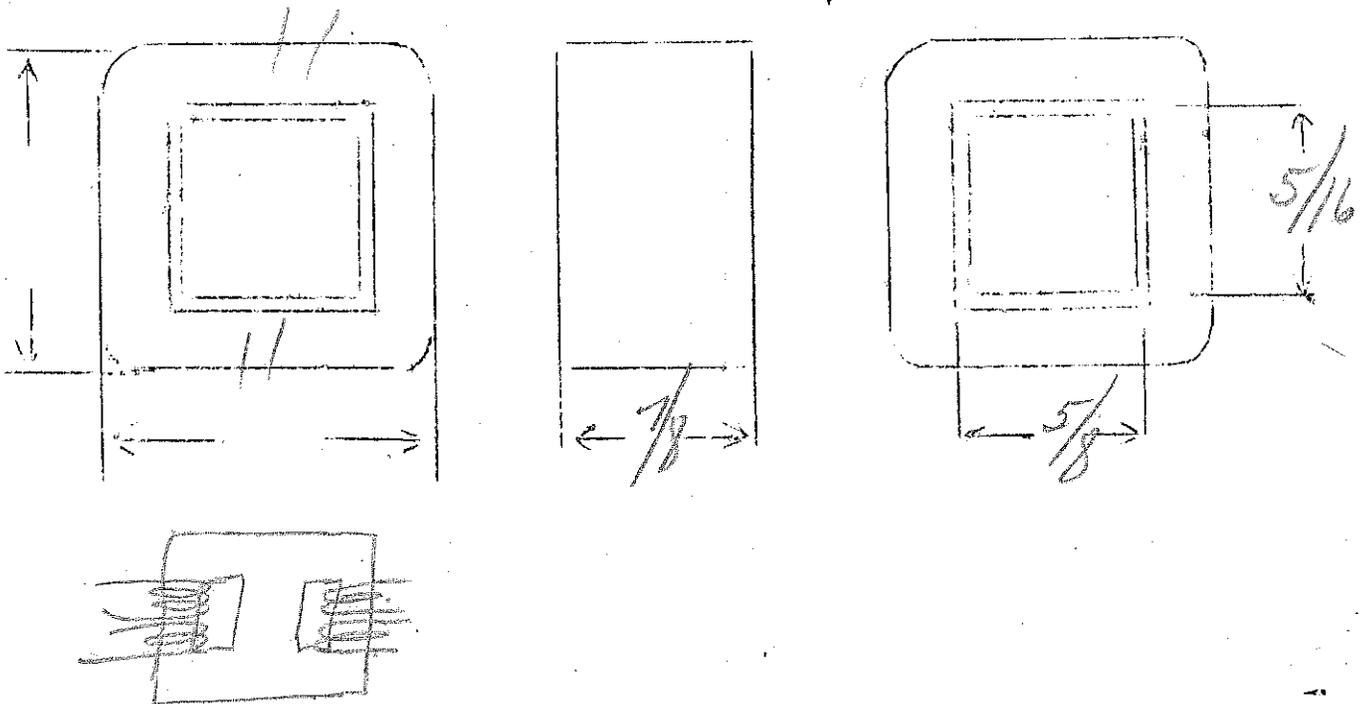

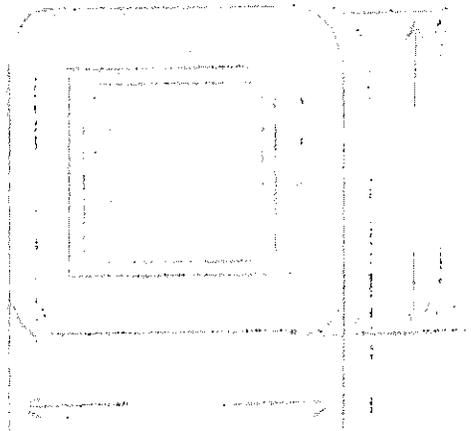
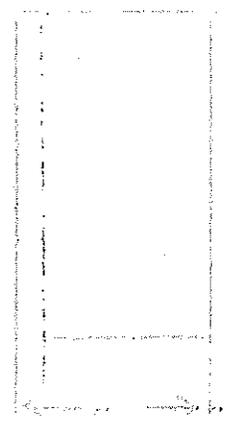
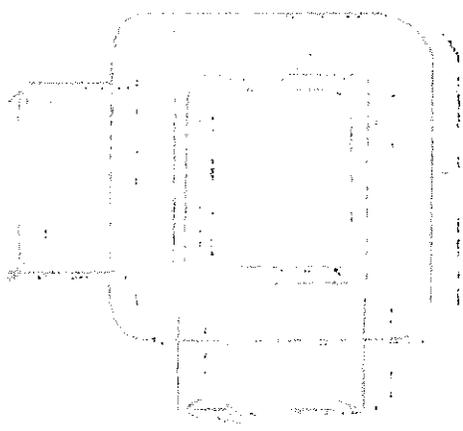
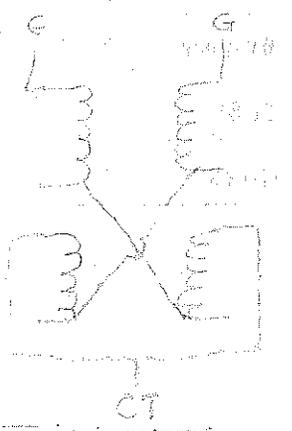
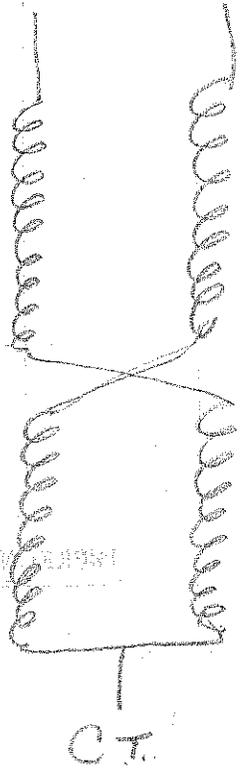

42 pentode connected to 7750 Class "A"

SPEC. NO. 1958

Winding	PR1	SFC				
Turns	4000	12000				
Taps	—	6000				
Wind. Lgth.	1.25	1.25				
Wire Size	#36	#39				
T.P.L.	202-20	288-42				
Kind Term.	#20 P Brand					
Term. Lgth.	9"	9"				
Layer Insul.	20 #	16 #				
Wrapper	1200 WC	2400584				
TUBE	7L007	IMPREGNATION		Varnish		
CURE	1X1 29#	Butt stack no gap				

note a tight winding

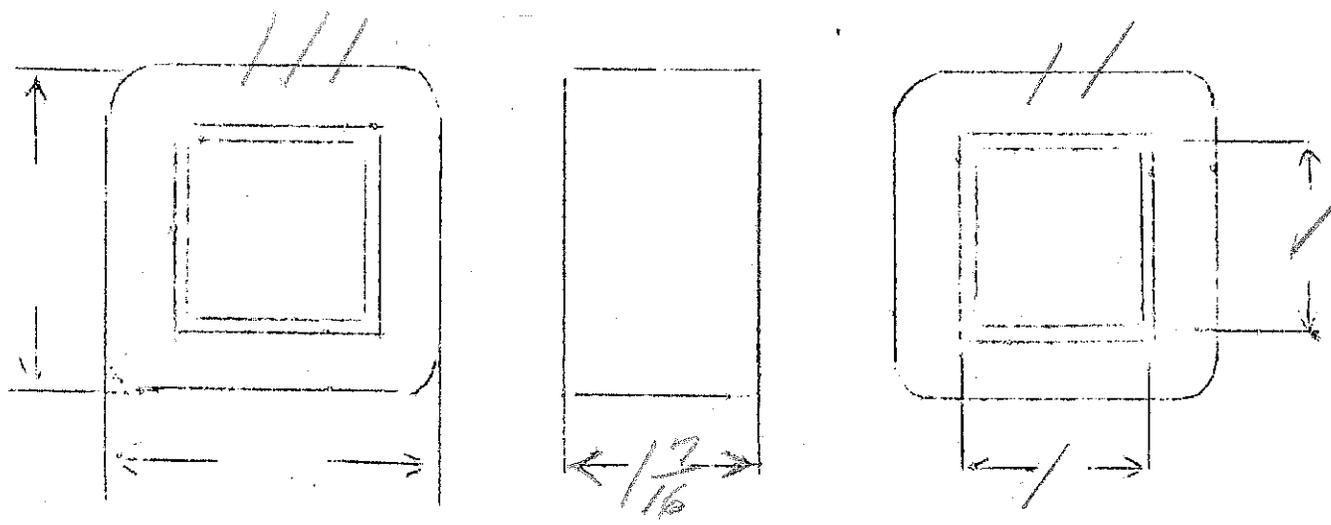

PP 50. Class A to VC
 8000 Ω CT PP to 3-6. 9.15-500 Ω lines

Continuous

SPEC. NO. 1959

Winding	PRI	SEC				
Turns	4300	950	73	38	88	
Taps	2150	—	45	—	—	
Wind. Lgth.	1.15					
Wire Size	#34	#30	#23	#22	#20	
T.P.L.	196-22					
Kind Term.	silver	WIRE	ONLY			
Term. Lgth.	3"	3"	3"	3"	3"	
Layer Insul.	30#	30#	—	—		
Wrapper	12007K	16056A			26056A	
TUBE	12007				IMPREGNATION	VARNISH.
CURE	1 1/16 x 1 5/8		1/2 x 1/16	1/26	2x2	

End of sec is start "0"

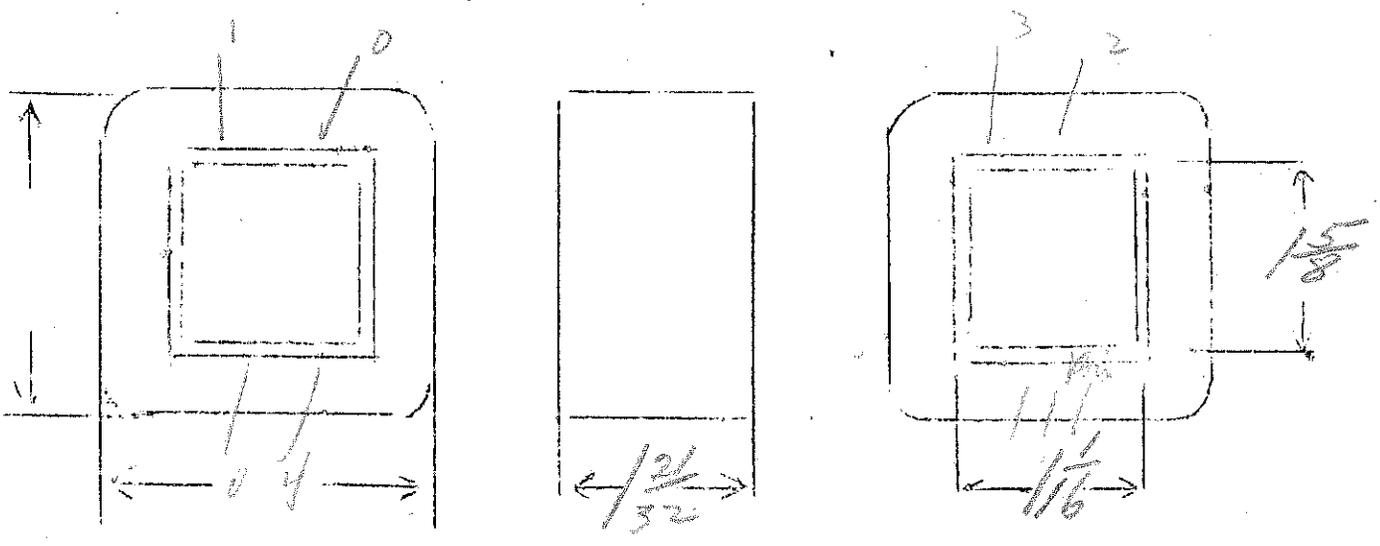

modulations
Pri - 10,000 Ω P-P

Sec. - 5000 Ω - 100 ma

Sec2 - 6000 Ω - 50 ma

30 watts

SPEC. NO. 1960

	Black White	Red	Blue			
Winding	PRI	SEC	SEC			
Turns	4400	3080	3440			
Taps	2200	—	—	top 1300 yellow		
Wind. Lgth.	1.75	1.75	1.75			
Wire Size	32	32	34			
T.P.L.	183-24	183-17	230-15			
Kind Term.	#70 Pur. Brand					
Term. Lgth.	9"	9"	9"			
Layer Insul.	30#	30#	30#			
Wrapper	2L07VC	2L07VC	2L007VC 2L005BA			
TUBE	2L007VC			IMPREGNATION	VARNISH	
CURE	1 1/4 x 1 1/4	1 1/2 x 1 1/2	1 1/2 x 1 1/2	2200	2200	2200

use heavy finishing - 029VC
0076A

Chromium case

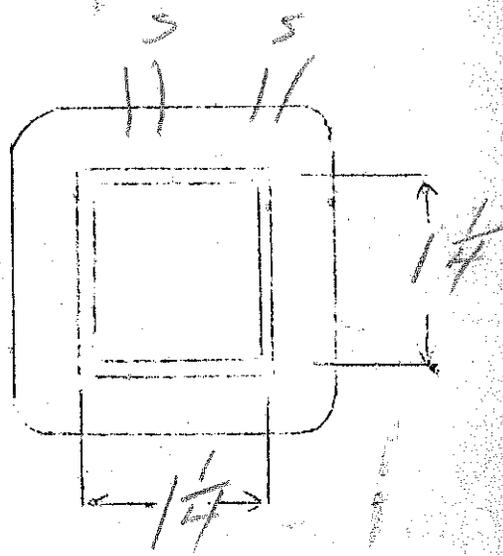
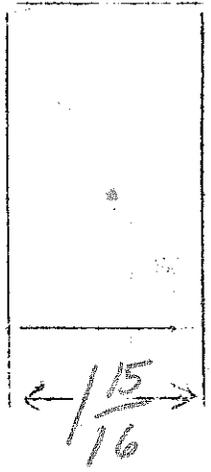
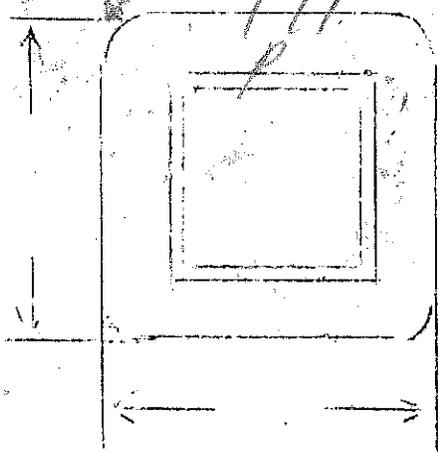

Connected EAG Class A to 2 AB 42's

AUDIO

SPEC. NO. 1961-BB

Winding	SEC	PR1				
Turns	10000	14000				
Taps	5000	7000				
Wind. Lgth.	1.25	1.25				
Wire Size	#40	#40				
T.P.L.	300	300				
Kind Term.	sil	sil				
Term. Lgth.	3"	3"				
Layer Insul.	16#	16#				
Wrapper	1/4" 100% 2005P	1/4" 100% 2005P				
TUBE	7L10 MIL 203VP		IMPREGNATION	WAX		
CURE	1 x 7/8		24% annealed		(2x2)	

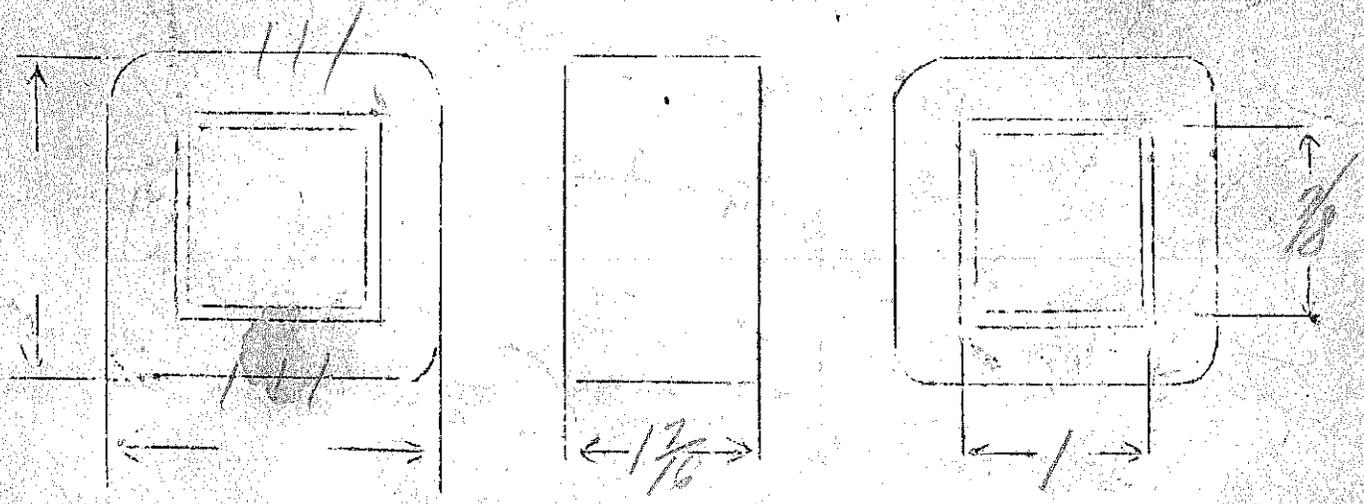

PP Connected 6A6 Class A to 2 AC 1/20

SPEC. NO.

1962

Winding	SEC	PR1				
Turns	8000	16000				
Taps	4000	8000				
Wind. Lgth.	1.25	1.25				
Wire Size	#40	#40				
T.P.L.	300	300				
Kind Term.	sil	Br				
Term. Lgth.	3"	3"				
Layer Insul.	16#	16#				
Wrapper	16007C 4L 20	200560				
TUBE	7L007		IMPREGNATION		WAX	
CURE	1X 1/2 29 1/2 connected 2x2					

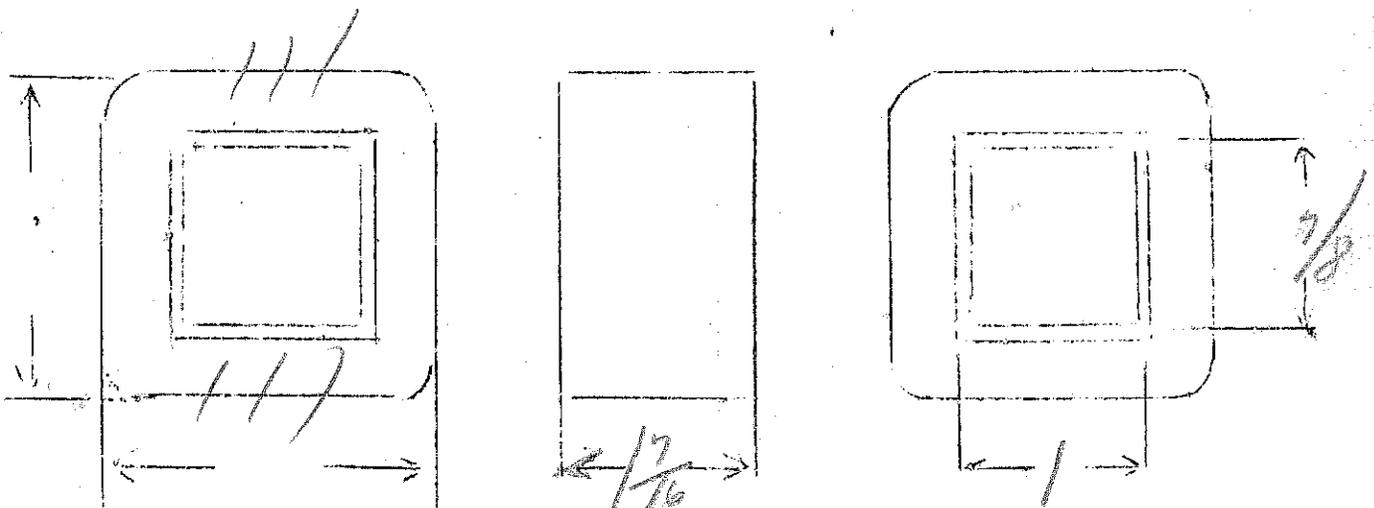

SPEC. NO. 1963

Winding	SEC	PR1				
Turns	9000	12000				
Taps	4500	6000				
Wind. Lgth.	1.25	1.25				
Wire Size	#40	#40				
T.P.L.	300	300				
Kind Term.	5cl Br					
Term. Lgth.	3"	3"				
Layer Insul.	16#	16#				
Wrapper	100715 21.10	21025 GA				
TUBE	7L007H1003VP		IMPREGNATION	WAX		
CURE	1X 7/8		29 ga annealed	2X2		

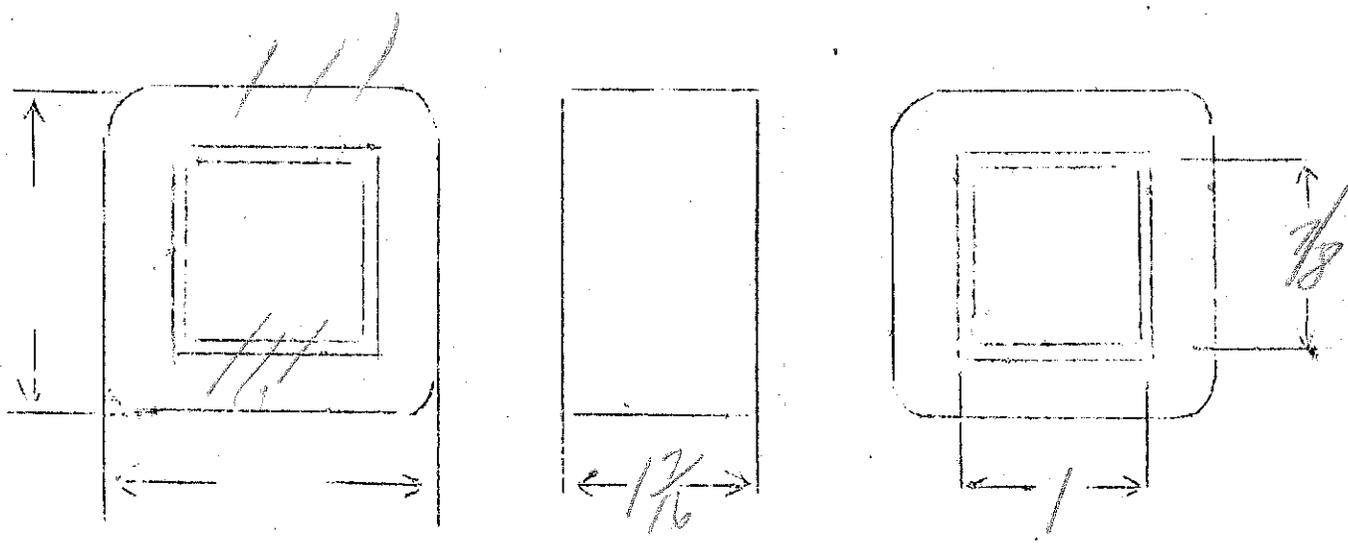

56 pt to two sec - each 3-1
 in range 25 to 300 N - "A" netg.

SPEC. NO. 1964

Winding	SEC	PRI	SEC			
Turns	9000	3000	9000			
Taps	—	—	—			
Wind. Lgth.	1.25	1.25	1.25			
Wire Size	#39	#39	#39			
T.P.L.	300-30	300-10	300-30			
Kind Term.	#20	Par Braid				
Term. Lgth.	9"	9"	9"			
Layer Insul.	16 #	16 #	16 #			
Wrapper	12007VC	12007VC	2200580			
TUBE	12007+12003VP			IMPREGNATION	Way	
CURE	1 X 7/8			29 # A Grade	2X2	

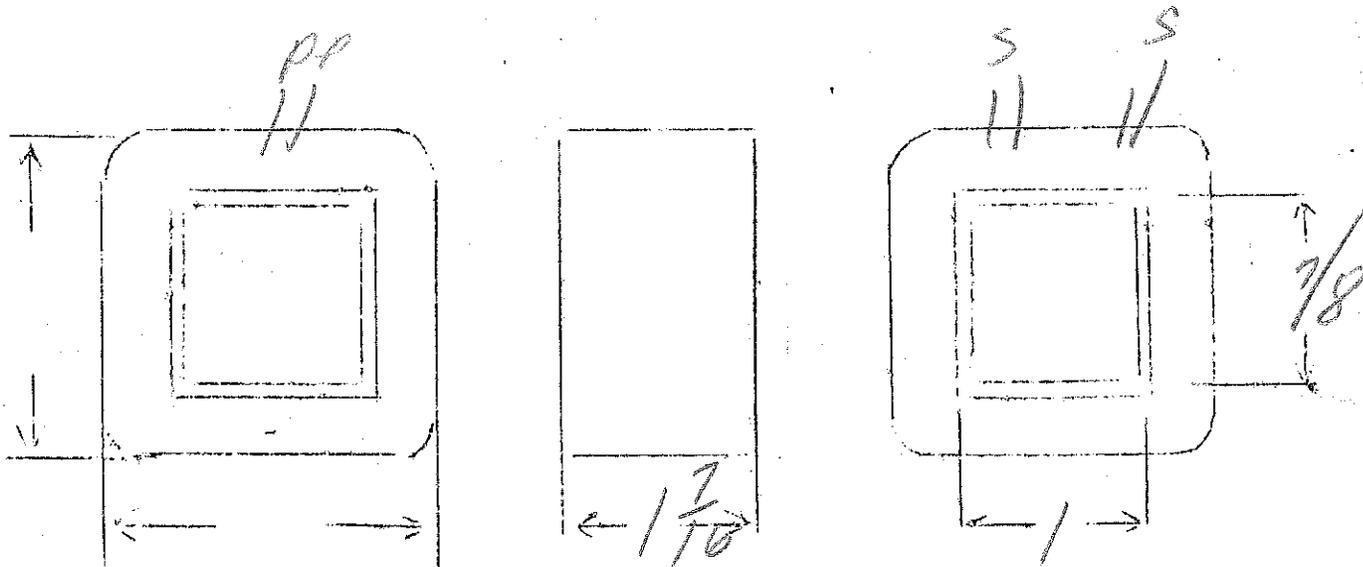

PP AB 6L6

3800 or 6000 Ω to

1.5-3-6-9-15-500 Ω

50-60 watt

(12)

324

Continuous

SPEC. NO.

1965

Winding	PR1	SEC	4:10	6:8	3:4		
Turns	2600 2340	630	48	23	57		
Taps	1300 260	3:8	28	—	17		
Wind. Lgth.	1.75	1.75	—	—	—		
Wire Size	#29	#27	#20	#18	#16		
T.P.L.	130 20	105-6	11	.6L	2L		
Kit 1 Term.	Sil Br	Sil Br	WIRE ONLY				
Term. Lgth.	3"	3"	3"	3"	3"		
Layer Insul.	40 μ	40 μ	100 μ Kraft				
Wrapper	110076 3:20	110076A			210076A		

TUBE 71007 IMPREGNATION VARNISH

CURE $1\frac{1}{4} \times 1\frac{1}{2}$ $\frac{1}{2}$ 26 hr, $\frac{1}{2}$ 29 hr 2x2

end of sec. is start of sec. impedance

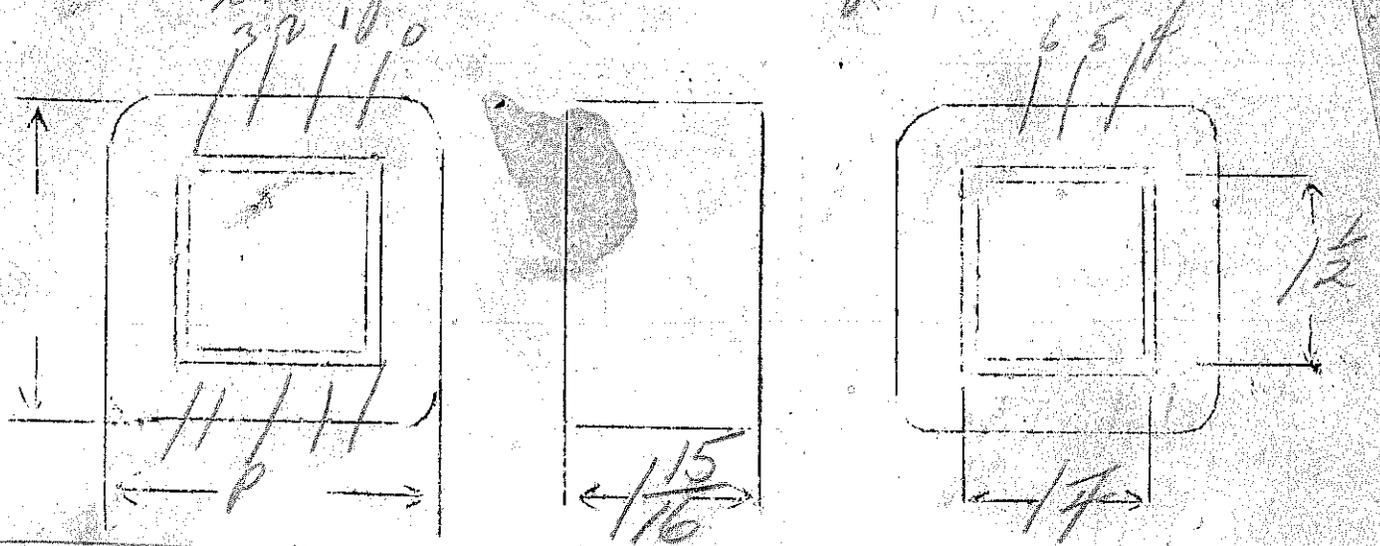

60 = 9
30 = 15
150 = 500
00

060000
00
038000
1965

1.5 V PRI
 600 CT }
 4800 CT } @300MA

THORNDARSON CO.
 PHOENIX ARIZ.

THORNDARSON
 SPEC. NO. T-19P65

Winding	SEC.		SHIELD		PRI.	
Turns	3724		1		70	
Taps	366-1862-3358		—		—	
Wind. Lgth.	2 ⁹ / ₁₆ "		2 ⁹ / ₁₆ "		2 ¹ / ₂ "	
Wire Size	#27		.001" Cu. Sheet		DOUBLE #15	
T. P. L.	150-26L		1		18-4L	
Finish	89%		—		85%	
Type Lead	#18 H-V. (Rubber Insul)		511. BR.		W.O. SLEEVE	(Lugs on leads to Parts on Panel)
Lead Lgth.	6" (to PANEL)		4" (CASE)		6"	
Layer Insul.	1-L 40-10.6		—		1-L .010"A	
Test Volt.	12,500 V		—		—	
Wrapper	3-L .007"VC 2-L .007"GA		2-L .007"VC 2-L .007"GA		1-L .007"VC 2-L .007"GA	

TUBE 10-L .007" GK-2-L .007" VC IMPREGNATION DOUBLE VARNISH

CORE 2¹/₈" (3³/₈" THORNDARSON) GA .24 GRADE D STACK 2 and 2

MOUNTING SPECIAL THORNDARSON CASE

Cu = 1120-620 PRI I = 10.5A
 Fe = 88M @ 6W 5/8
 TPV = 0.608
 WN = 0.724 (.718)

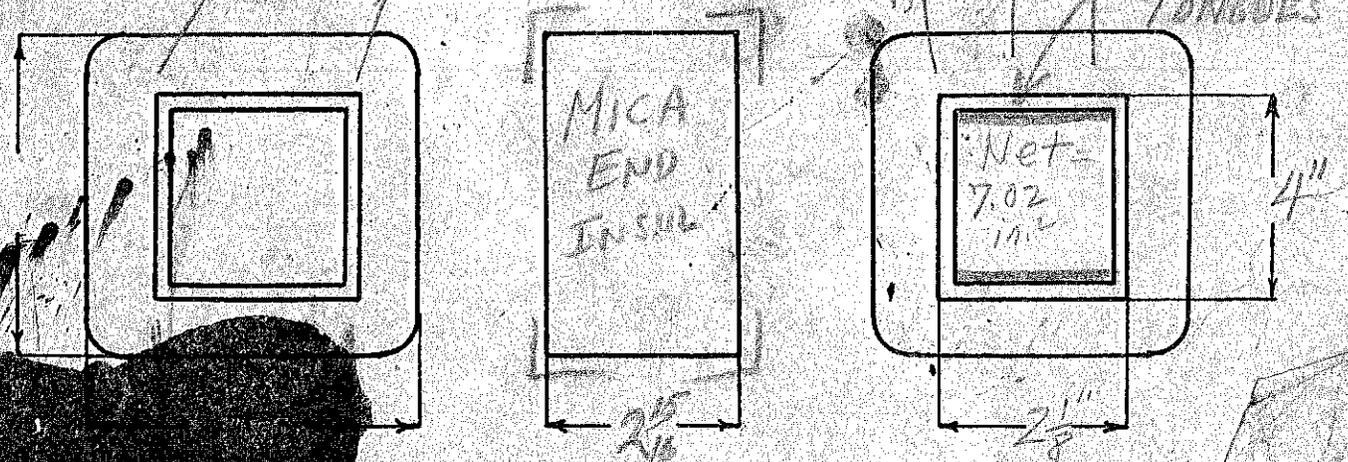

DATE 8-12-42

THORNTON
7-19-65

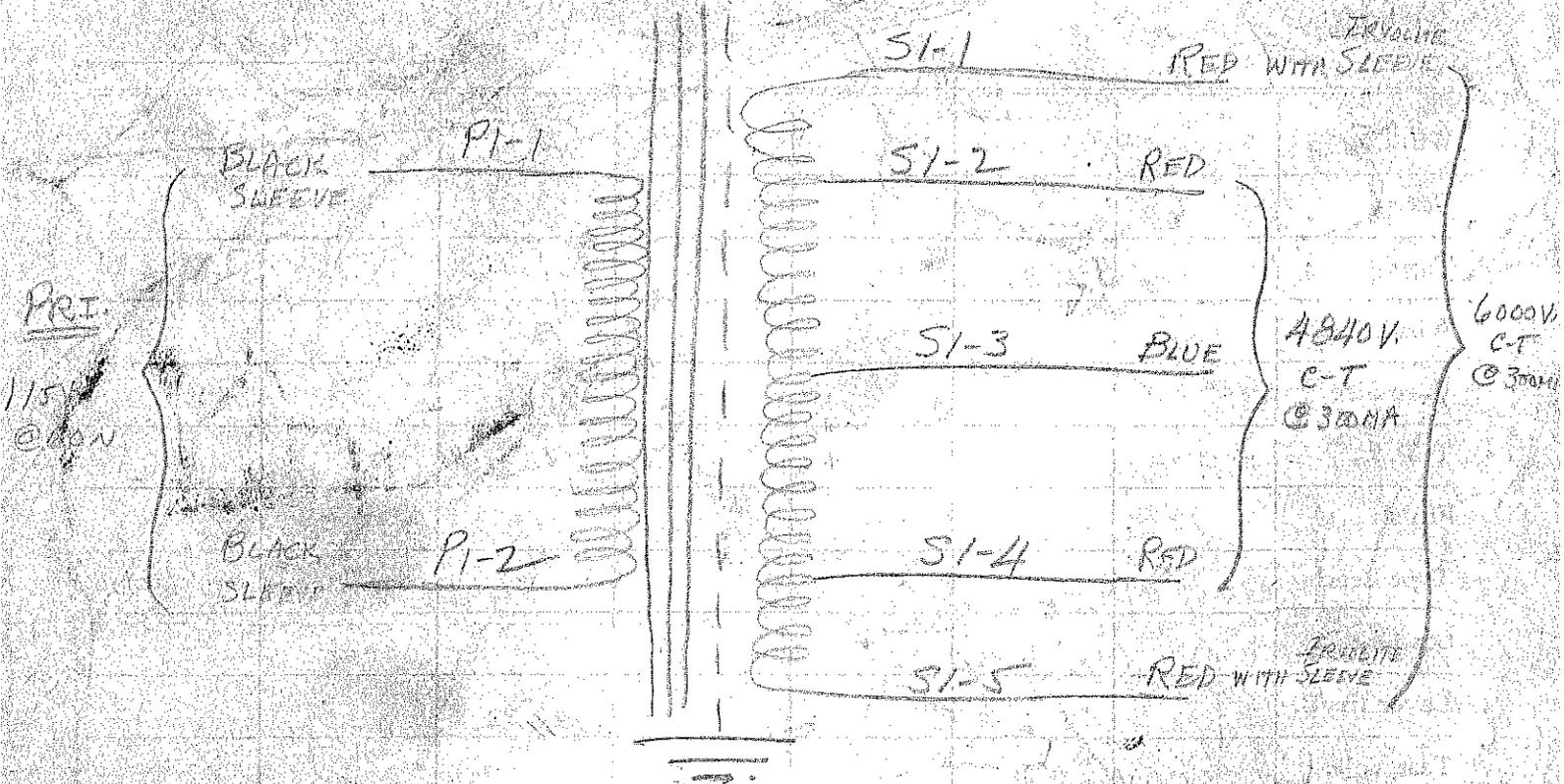

Attach Leads to Binding Posts on Case, using Lugs on ends of leads.

14000 to 4.8 Ω V.C.

SPEC. NO.

1966

Winding	P	S				
Turns	4400	83				
Taps	2200					
Wind. Lgth.	7/8	7/8				
Wire Size	#37	#22				
T.P.L.	158-28	3L				
Kind Term.	SIL BR	WIRE ONLY				
Term. Lgth.	3"	3"				
Layer Insul.	20#	-				
Wrapper	2L005GA	2L005GA				
TUBE	7L009		IMPREGNATION		Varnish	
CURE	3/4 x 3/4	-	4x4		29.216	

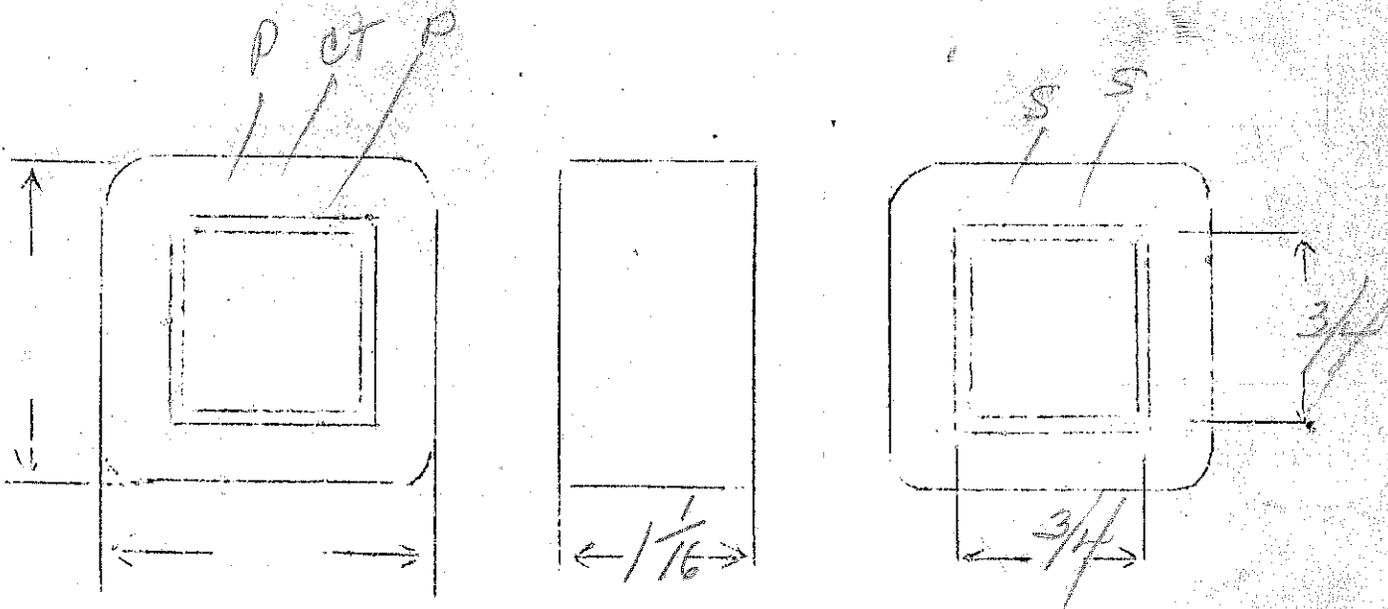

500 r to pp 212D Class B

$$\frac{N}{F} = 7$$

SPEC. NO. 1967

Winding	PRI	SEC				
Turns	1200	3800				
Taps	—	1900				
Wind. Lgth.	1.75	1.75				
Wire Size	#26	#30				
T.P.L.	93-13	147-26				
Kind Term.	WIRE ONLY					
Term. Lgth.	3"	3"				
Layer Insul.	40#	40#				
Wrapper	21007VC	21007VC				
TUBE	7L007	IMPREGNATION		VARNISH		
CURE	1 1/4 x 1 3/8	1/2 x 1/2	1/2 x 1/2	1/2 x 1/2	2 x 2	

1000 volt finishing

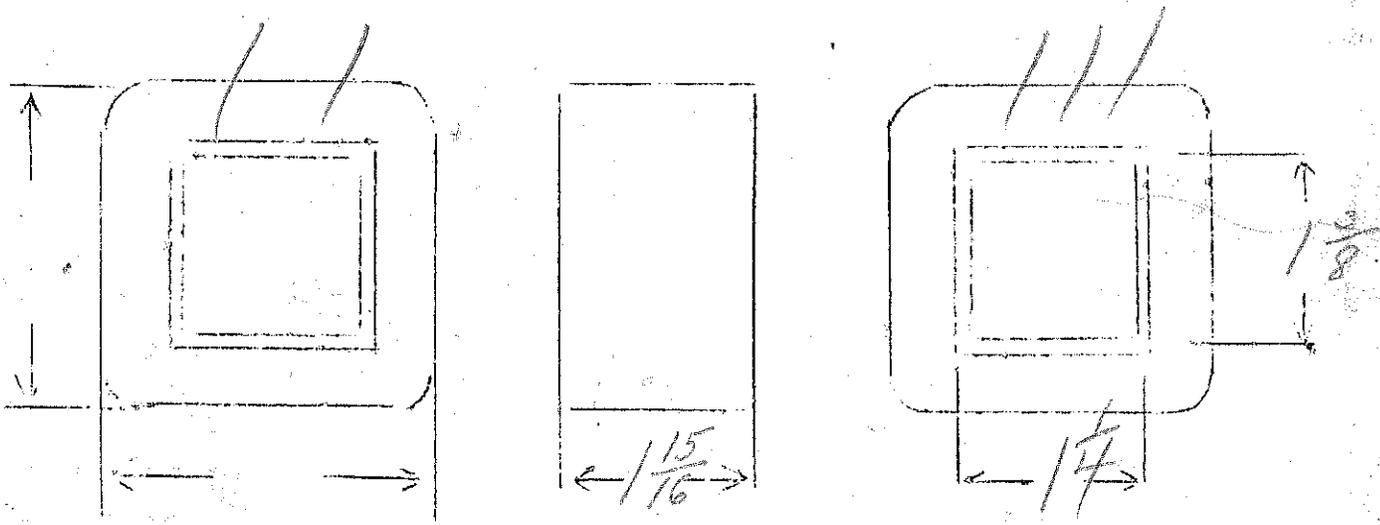

CONSOLIDATED ENGINEERING CO.

CHOKE
2615H @ No DC.
R=1950.2
Q212 @ 956N

1967-C
~~1966-C~~

R=1950.2

SPEC. NO.

Winding		CHOKE					
Turns		6800					
Taps		5440 32 nd L.					
Wind. Lgth.		$\frac{19}{32}$ "					
Wire Size		#41					
T. P. L.		170-40L					
Finish		89%					
Type Lead		#32 PK OR					
Lead Lgth.		6" FROM COIL					
Layer Insul.		1-L 14-66.6					
Test Volt.		500V					
Wrapper		2-L .005" GK					

TUBE 4-L .007" GK + 2-L 14-66.6 IMPREGNATION VARNISH

CORE F-12 x 1/2" GA. 29-6A F-12 GRADE AUDIO-A STACK BUTT-.015" GAP

MOUNTING SPECIAL

WN = .160 (.156)

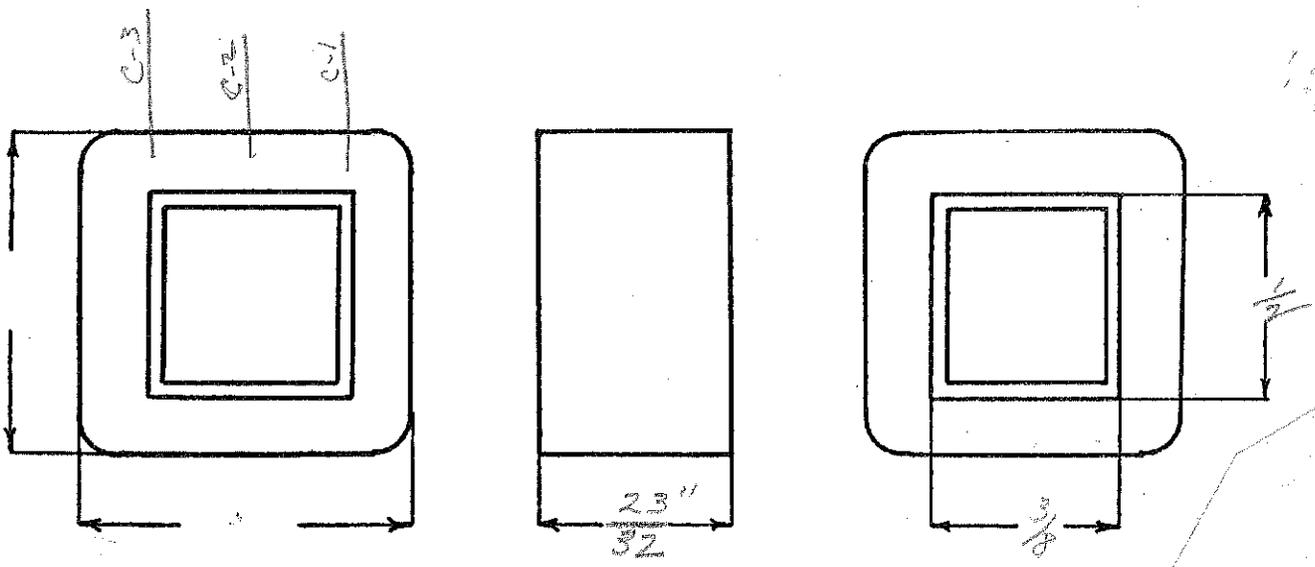

RE DESIGNED BY *W.H.H.*

DATE 8/4/43

1966

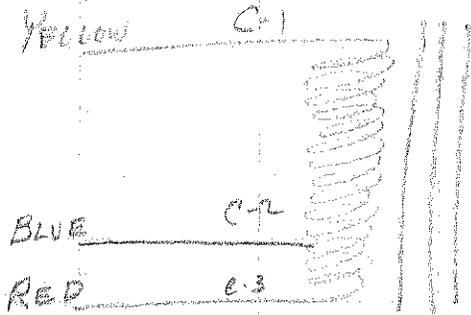

L = 50 - 30
 LR = 1.67 - 1
 FR = 1.79 - 1
 T = 6800 - 5270

26.5
 1.50
 2.00

Capacity 1 =

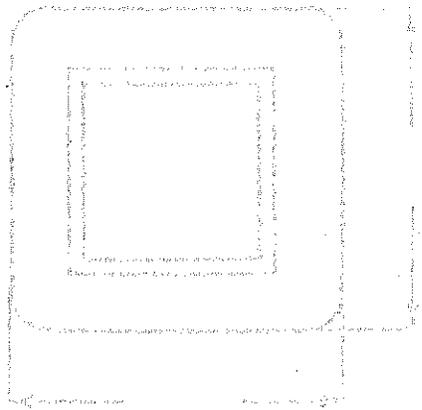
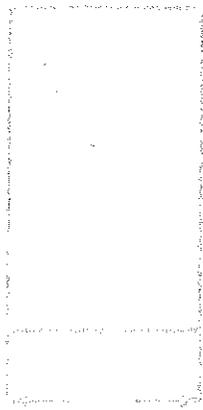
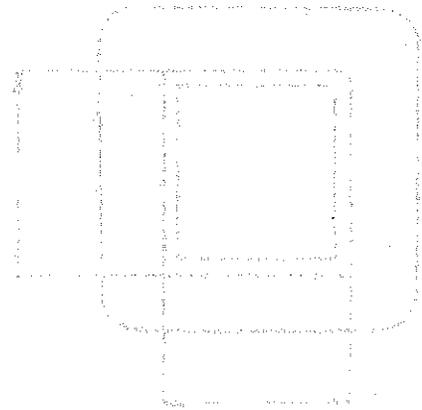

2.11

2.11

PP42 to 92VC

SPEC. NO. 1968

Winding	P	S				
Turns	4400	108				
Taps	2200	—				
Wind. Lgth.	15/16	—				
Wire Size	37	23				
T.P.L.	158	—				
Kind Term.	oil Br	W.O				
Term. Lgth.	3"	3"				
Layer Insul.	16#					
Wrapper	210056A	210056A				
TUBE	7L007		IMPREGNATION	Varnish		
CURE	3/4 X 3/4 — 29/40 B Grade			2x2		

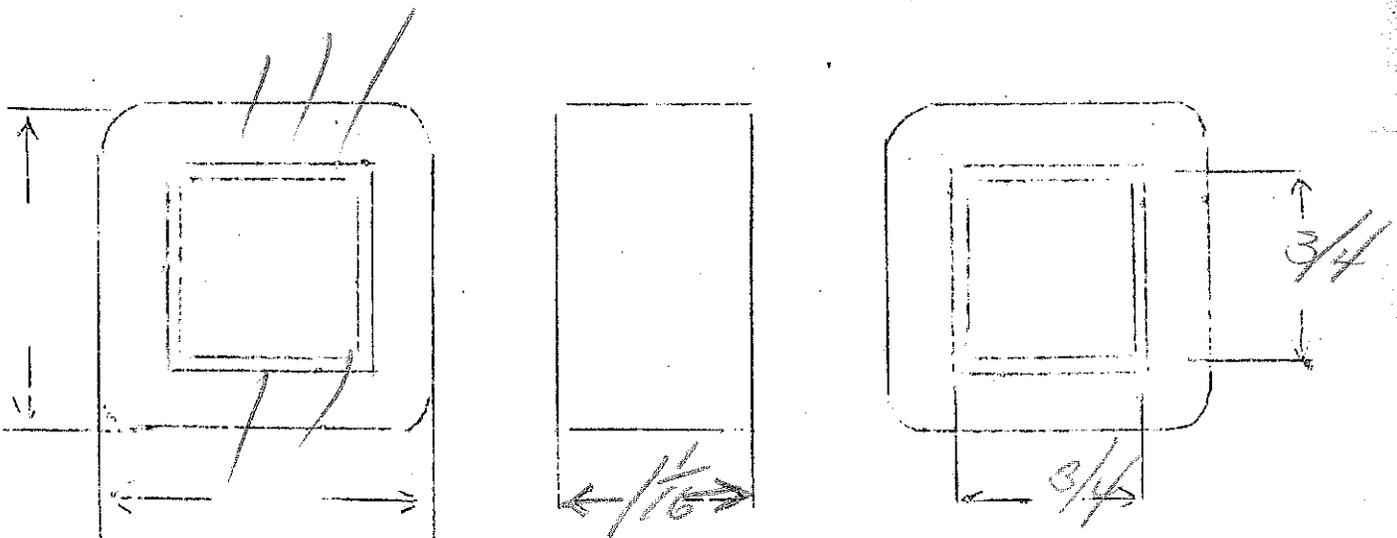

CHOKE
 2.62H @ 40 DC
 R=1952
 Q>12 @ 956V

SPEC. NO. **1968-C**

195-a

Winding	CHOKE					
Turns	2280					
Taps	—					
Wind. Lgth.	$\frac{19}{32}$ "					
Wire Size	#36					
T. P. L.	95-24L					
Finish	88%					
Type Lead	#22 PR BR					
Lead Lgth.	6" FROM COIL					
Layer Insul.	1-L 20-LB.6					
Test Volt.	500V.					
Wrapper	2-L .005" GK					

TUBE A-L .007" GK + 1-L .003" VP IMPREGNATION VARNISH

CORE F-12 x $\frac{1}{2}$ " GA. 29-60. F-12 GRADE AUDIO-A STACK BUTT- No 600

MOUNTING SPECIAL - SAME AS FOR #1967-C

W. N. # .158(.156)

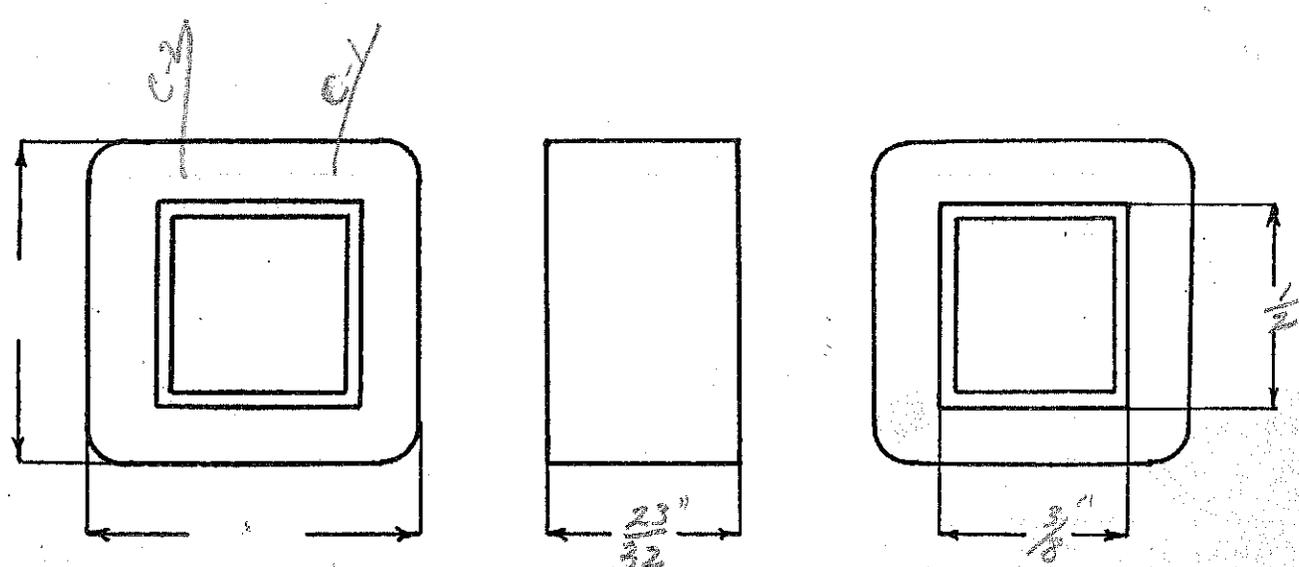

RE-DESIGNED BY HHH

DATE 8/11/43

1968

5001

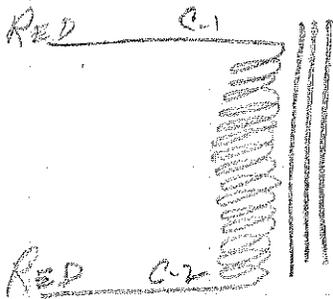

Handwritten notes on the right side of the page, including the word "width" and other illegible characters.

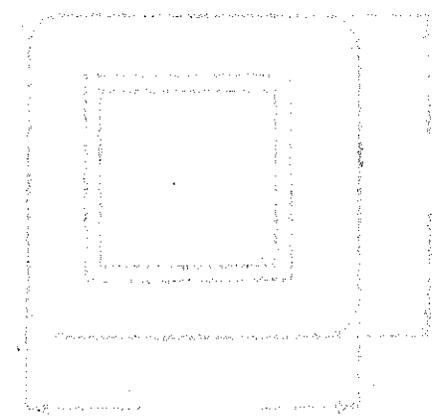
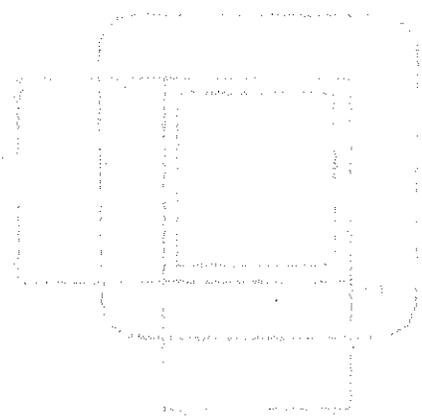

Handwritten text at the bottom center of the page.

Handwritten text at the bottom right of the page.

30 r - 1 r

SPEC. NO. 1970

Winding	PRI	SEC					
Turns	210	1 1/2					
Taps	-	-					
Wind. Lgth.	5/8	5/8					
Wire Size	#31	#18					
T.P.L.							
Kind Term.	silbr	W/O					
Term. Lgth.	4"	4"					
Layer Insul.	30 #	-					
Wrapper	210056A	210056B					
TUBE	4007	IMPREGNATION	VARNISH				
CURE	1/2 x 1/2 special permittay.						

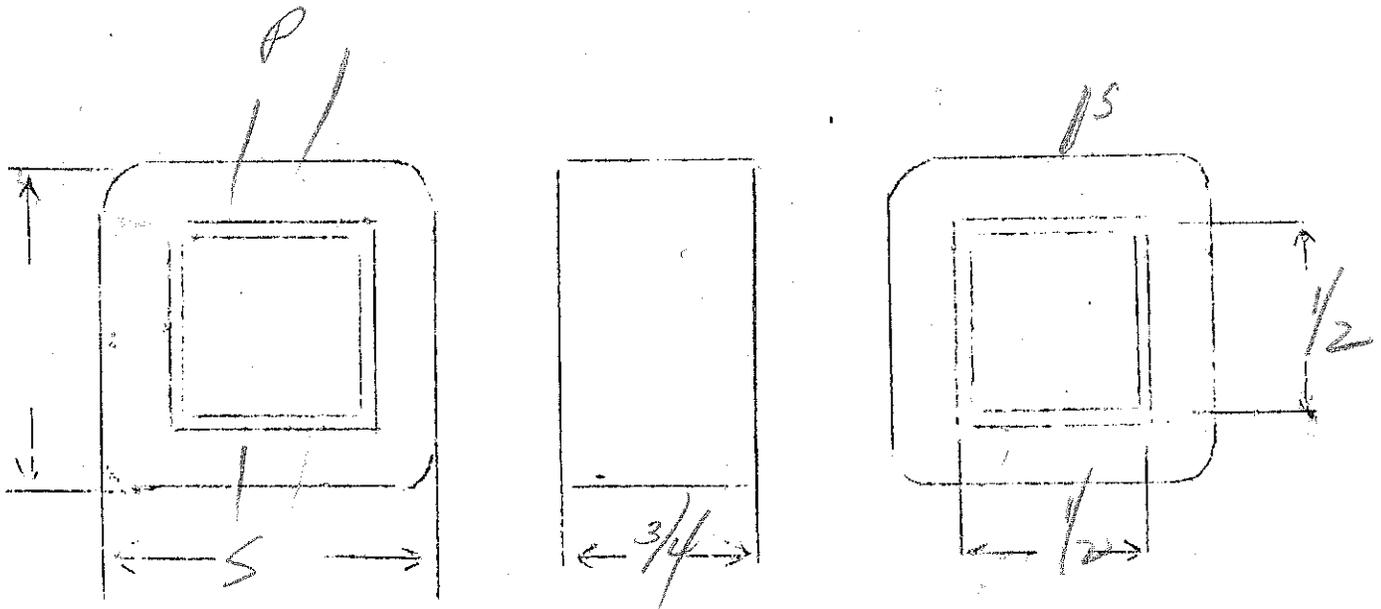

PRK - 8000 Ω P-P
 SEC₁ - 2500 Ω - 75 ma
 SEC₂ - 12000 Ω - 35 ma

SPEC. NO. 1971

	Black white	Red	Blue				
Winding	PR1	SEC	SEC				
Turns	4000	3800	4850				
Taps	2000	-					
Wind. Lgth.	1.75	1.75					
Wire Size	#32	#33	#35				
T.P.L.	183-22	202-19	256-19				
Kind Term.	#20	Per Br					
Term. Lgth.	9"	9"	9"				
Layer Insul.	30#	30#	30#				
Wrapper	21007VC	21007VC	11007VC 21005GA				
TUBE	71007 + 11007VC			IMPREGNATION	VARNISH		
CURE	1/4" x 1/4"		1/2 29th 1/2 26th Hop 510"				

heavy finishing

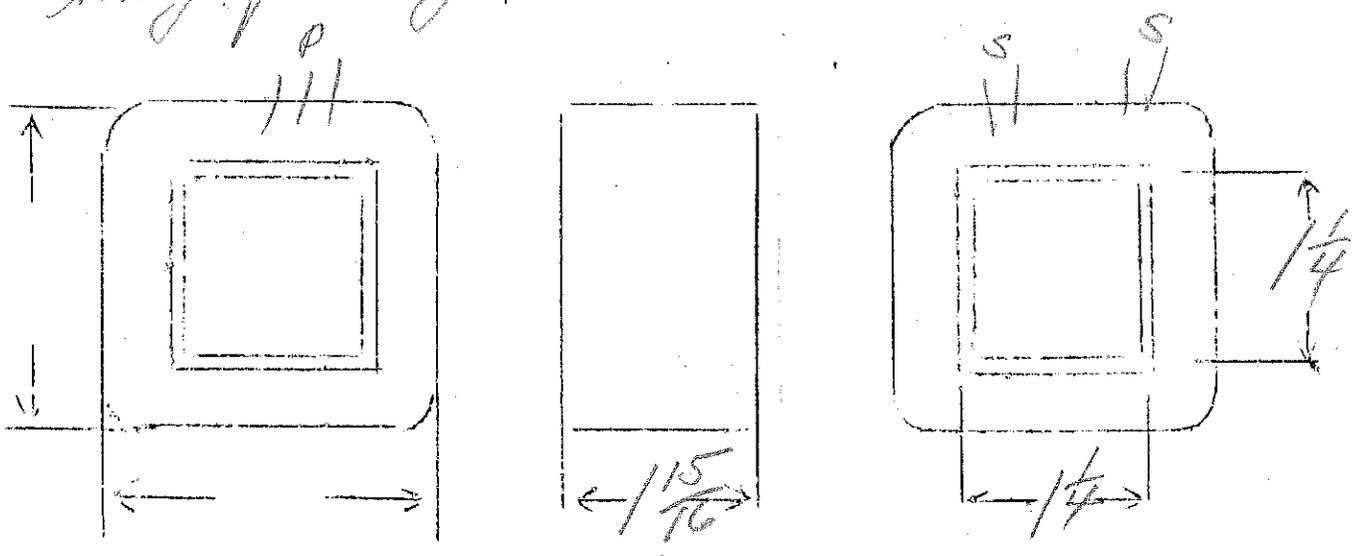

Pentode to 500 ohm line

SPEC. NO. 1972

Winding	P	S				
Turns	2500	670				
Taps						
Wind. Lgth.	3/4	3/4				
Wire Size	38	32				
T.P.L.	150	75-9				
Kind Term.	Sil Br	Sil Br				
Term. Lgth.	3"	3"				
Layer Insul.	16#					
Wrapper	1L007VC	2L005EA				
TUBE	4L007		IMPREGNATION		VARMISH	
CURE	6 x 6	29 hr	Step 003			

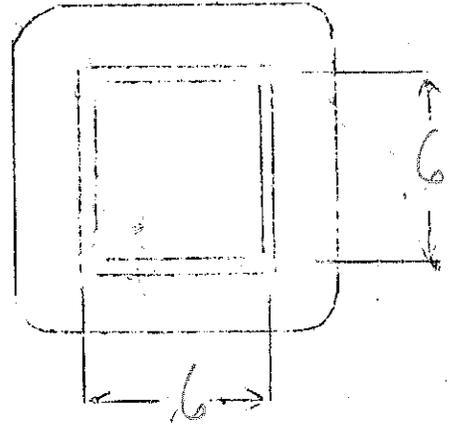
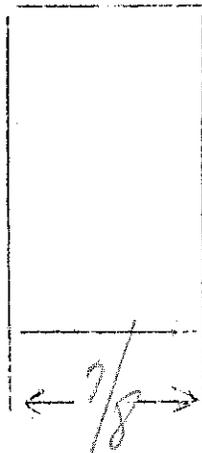
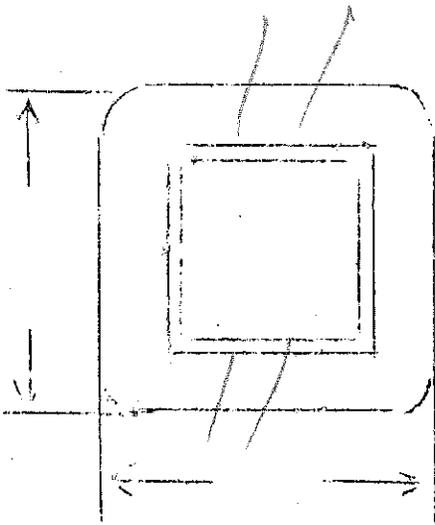

14000 to 92vc

SPEC. NO. 1973

Winding	P	S					
Turns	4400	114					
Taps	2200	-					
Wind. Lgth.	7/8	7/8					
Wire Size	#27	#23					
T.P.L.	158-28						
Kind Term.	SIL BR	WIRE ONLY					
Term. Lgth.	3"	3"					
Layer Insul.	20#						
Wrapper	2L0056A	2L0050A					
TUBE	7L007			IMPREGNATION		VARNISH	
CURE	3/4x 3/4			4x4 29/32			

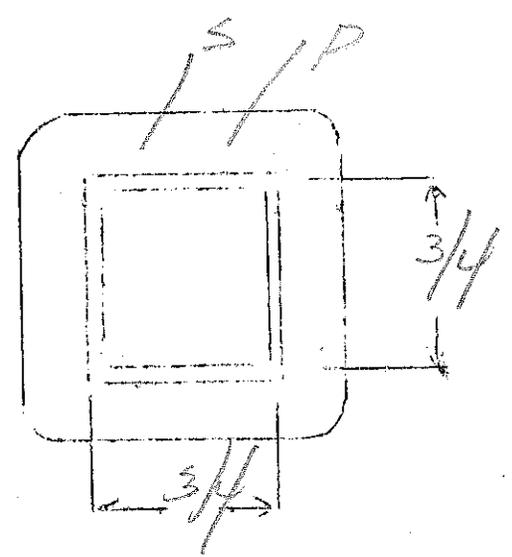
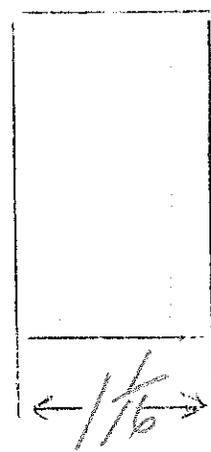
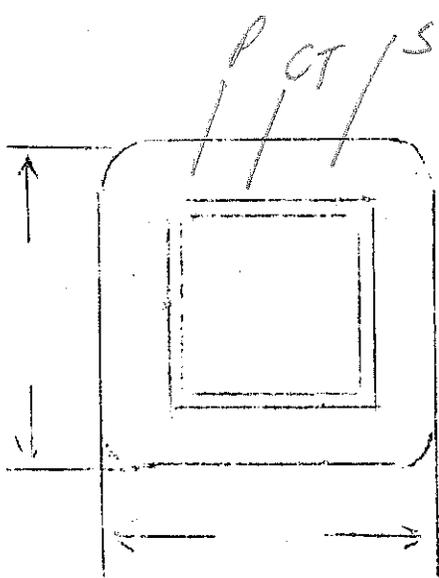

14000 to 22 VC

SPEC. NO. 1974

Winding	P	S					
Turns	4400	53					
Taps	2200						
Wind. Lgth.	7/8	7/8					
Wire Size	#37	#20					
T.P.L.	158-28	—					
Kind Term.	SILBY	WIDE ONLY					
Term. Lgth.	3"	3"					
Layer Insul.	20#	—					
Wrapper	210056A	210056A					
TUBE	76007			IMPREGNATION		VARNISH	
CURE	3/4 X 3/4	4 X 4	29 1/2	R Grade			

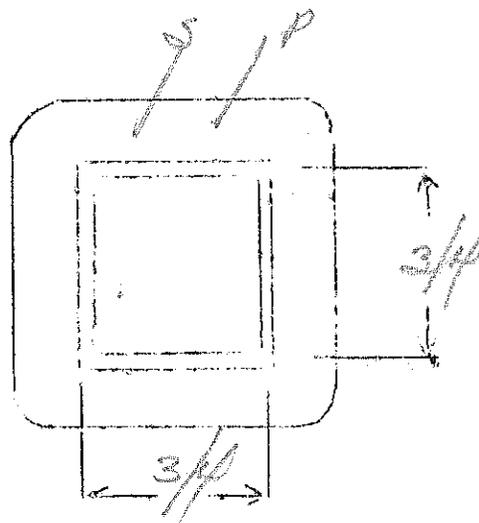
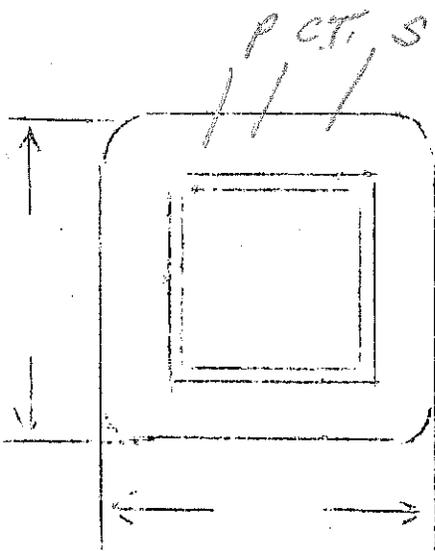

14000 to 3.52 VC

SPEC. NO. 1975

Winding	P	S					
Turns	4400	71					
Taps	2200	—					
Wind. Lgth.	7/8	7/8					
Wire Size	37	21					
T.P.L.	158-28	—					
Kind Term.	Sil Br	WIRE ONLY					
Term. Lgth.	3"	3'					
Layer Insul.	20#	—					
Wrapper	210056A	210056A					
TUBE	47007		IMPREGNATION		VARNISH		
CURE	3/4 x 3/4		4x4		29 1/2 B-		

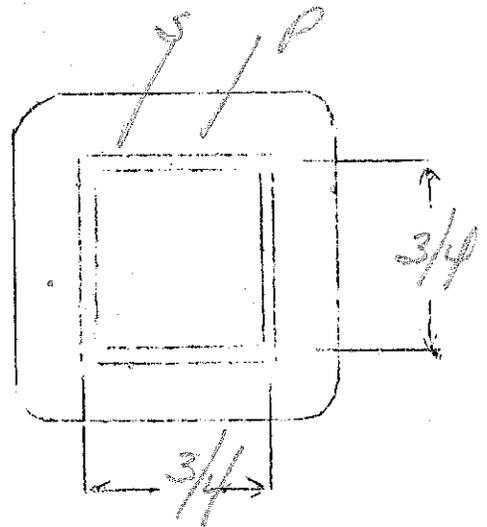
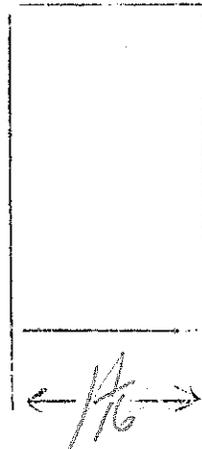
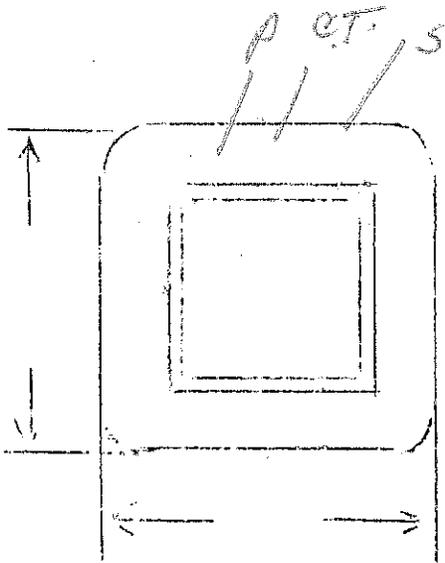

P.P 655 to 12 Ω VC.

24

SPEC. NO. 1976

Winding	PRI	SEC					
Turns	4200	144					
Taps	2100						
Wind. Lgth.	1.25	1.25					
Wire Size	#34	#21					
T.P.L.	162-26	4L					
Kind Term.	nl Pr	WIPE ONLY					
Term. Lgth.	3"	3"					
Layer Insul.	30#	—					
Wrapper	21056A	21056A					
TUBE	72007		IMPREGNATION	VARNISH			
CURE	1 x 1/4		— 2x2 —	1/2 26/30 1/2 29/30			

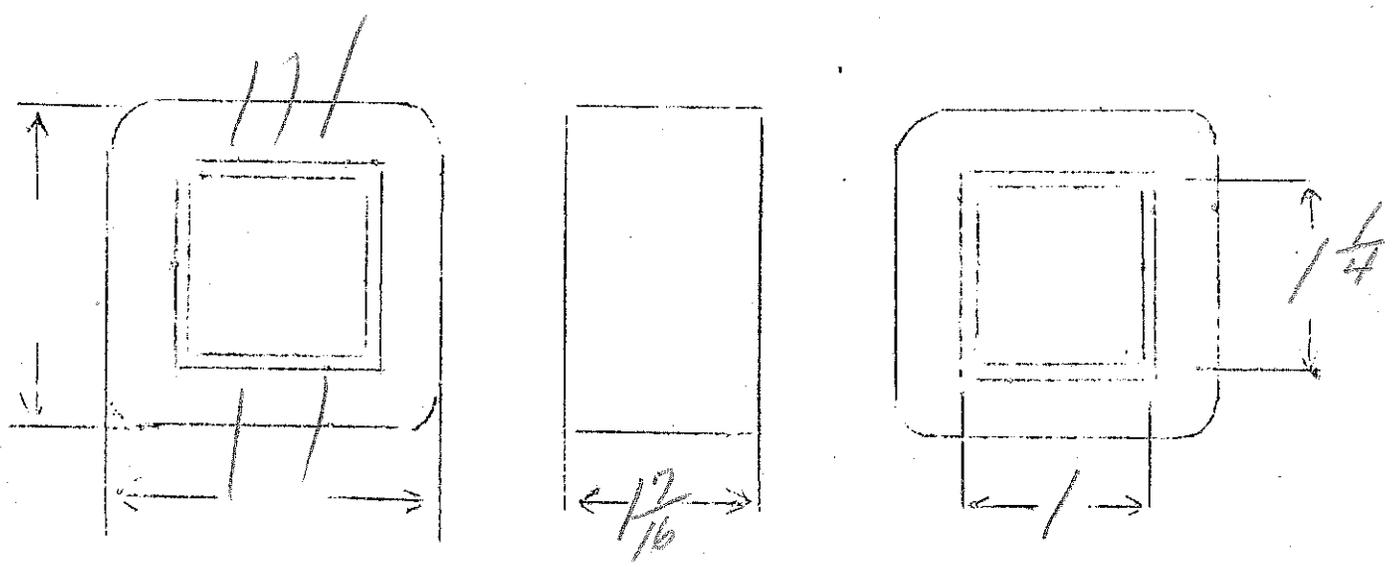

14000 to 152vc

SPEC. NO. 1977

Winding	P	S					
Turns	4000	41					
Taps	2000	—					
Wind. Lgth.	1 1/16	—					
Wire Size	#35	#20					
T.P.L.	155-26	— 24					
Kind Term.	sil Bi	WIRE ONLY					
Term. Lgth.	3"	3"					
Layer Insul.	30#						
Wrapper	2L0056A	2L0056A					
TUBE	7L007		IMPREGNATION		VARNISH		
CURE	7/8 x 7/8 2x2						

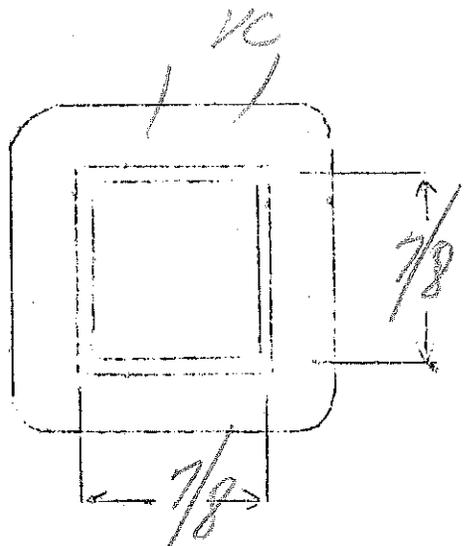
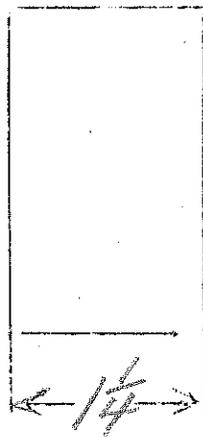
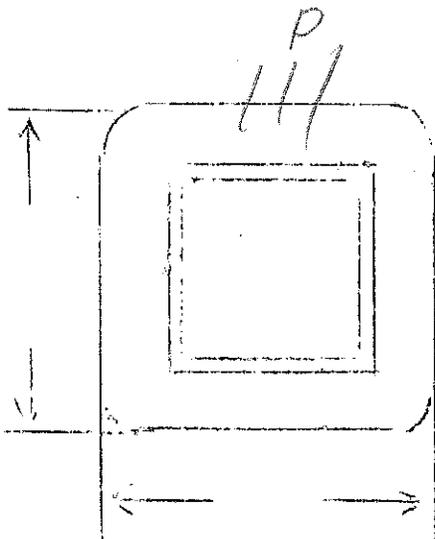

82 to grid

SPEC. NO. 1978

Winding	SEC	PR1				
Turns	7900	70				
Taps	—					
Wind. Lgth.	3/4	3/4				
Wire Size	#40	#27				
T.P.L.	190-42					
Kind Term.	Sil Pr	WIRE ONLY				
Term. Lgth.	3"	3"				
Layer Insul.	12#	40#				
Wrapper	24056A	24056A				
TUBE	44007			IMPREGNATION		WAX
CURE	6x6	29-9	2x2			

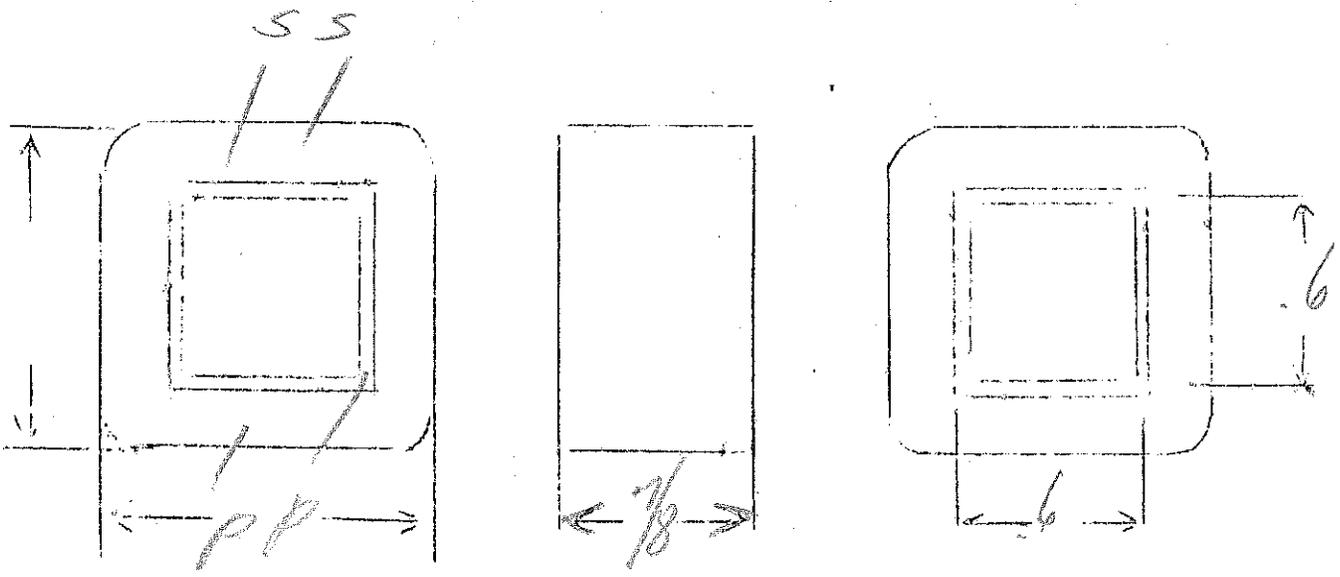

Crystal mike to 50.2

30-10,000.2

SPEC. NO. 1979

Winding	P	S				
Turns	6000	300				
Taps	-	-				
Wind. Lgth.	1/4	3/2				
Wire Size	#40	#25				
T.P.L.	68-	180-17				
Kind Term.	sil br	sil br				
Term. Lgth.	4"	4"				
Layer Insul.	12#	30#				
Wrapper	210056A	210056A				
TUBE	72007		IMPREGNATION	VARNISH		
CURE	1x 7/8	29 to annealed	2x2			

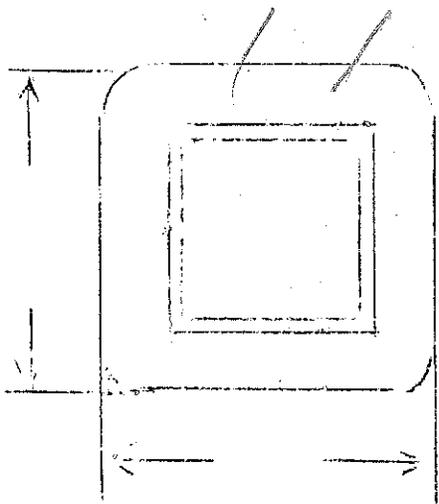

over

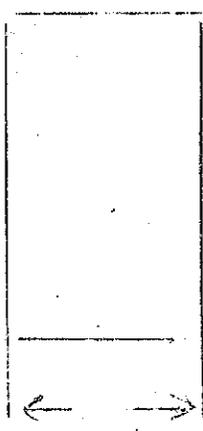

P - 3/8
S - 1/2"

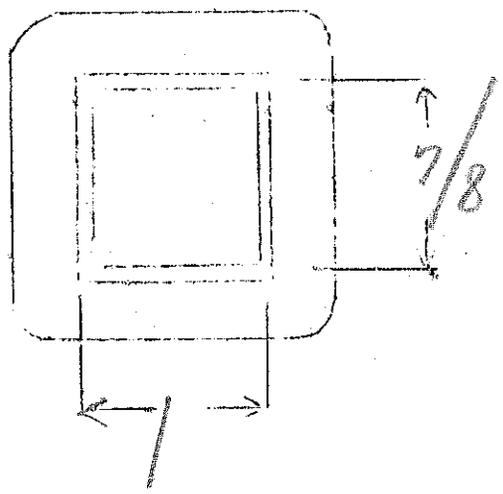

$$\frac{100000\phi}{50} = 2000$$

$$\frac{N_1}{N_2} = 44.8$$

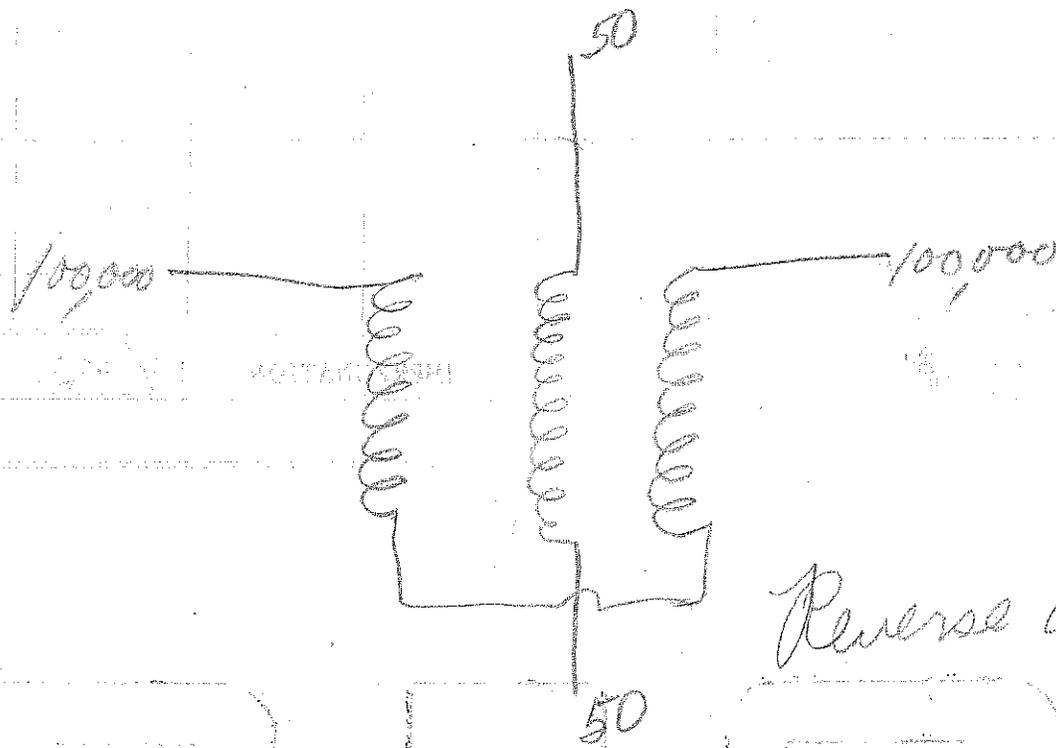

Reverse Assembly

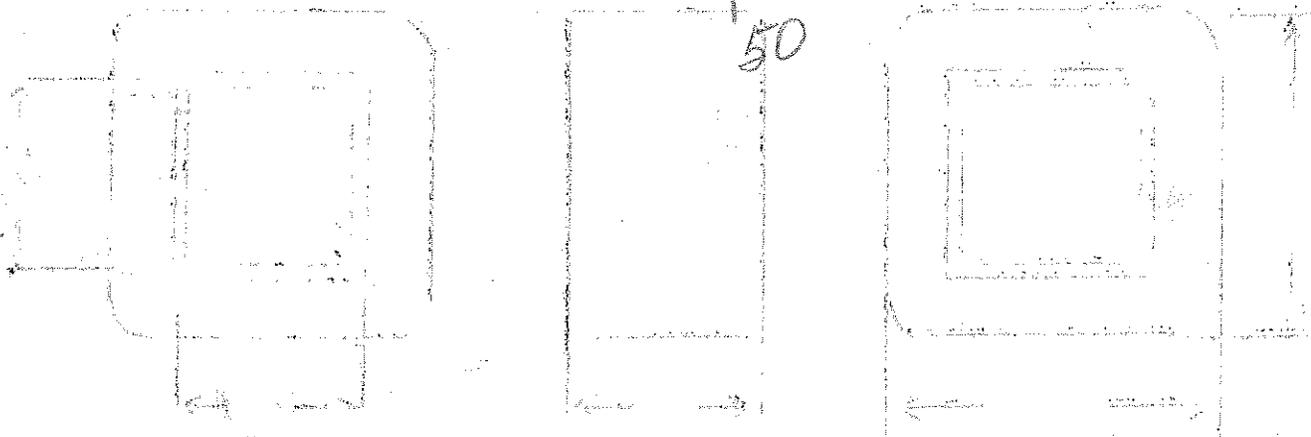

PP2A3 (5000 a) to 2.5, 5, 7.5, 15 sec

CONTINUOUS SPEC. NO. 1980

Winding	PRI	SEC				
Turns	2800	63	45	45		
Taps	1400		25			
Wind. Lgth.	1 1/6	1 1/6				
Wire Size	#35	#20	22	24		
T.P.L.	157-18					
Kind Term.	Sil Br	WIRE ONLY				
Term. Lgth.	3"	3"	3"	3"		
Layer Insul.	30#		50#			
Wrapper	20058A			20058A		
TUBE	7007	IMPREGNATION		VARNISH		
CURE	7/8 x 7/8	2x2				

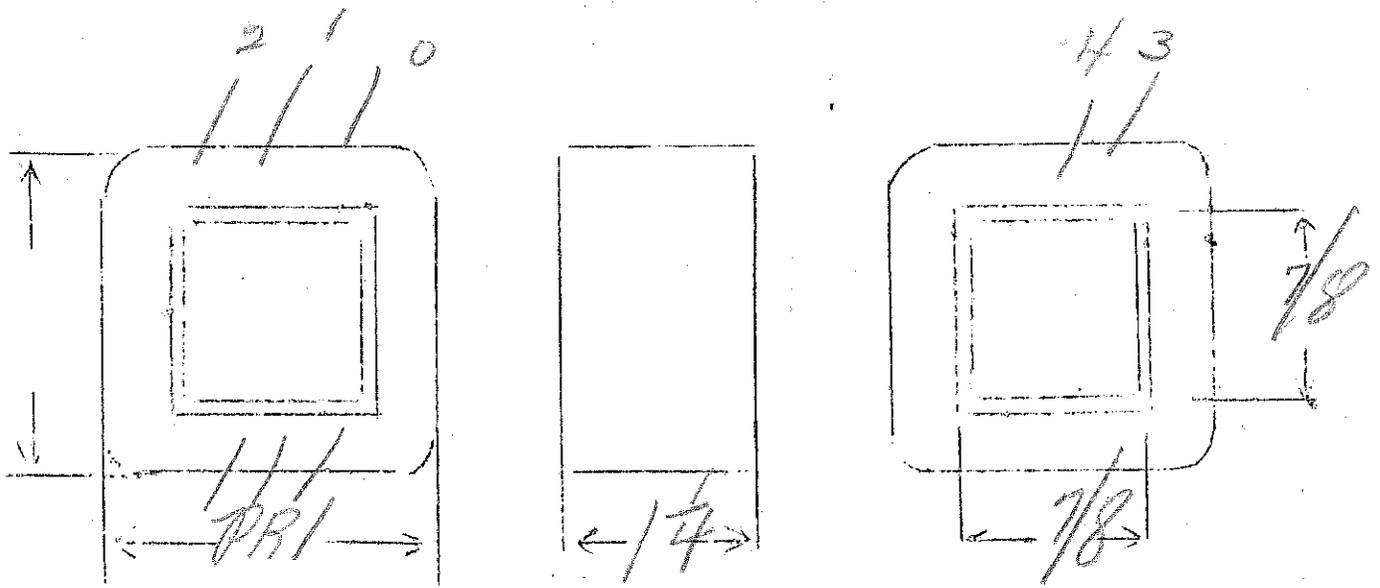

2.6
1.0
1.8
1.8

PP50 - Class A to
3-6-975-5000

8000Ω p-p

SPEC. NO. 1981

Continuum

Winding	P	S				
Turns	4200	950	43	38	88	
Taps	2100		75			
Wind. Lgth.	1 1/8	1 1/32	→			
Wire Size	#32 #35	#30	23	21	19	
T.P.L.	210-20	120				
Kind Term.	Sil	Braid	WIRE ONLY			
Term. Lgth.	4"	4"	→			
Layer Insul.	30#	30#	50#	→		
Wrapper	1L007V6			2L0050A		
TUBE	7007		IMPREGNATION		VARNISH	
CURE	1 1/16 x 1 1/16	2x2	1/22980	1/22680		

End of sec is start 0"

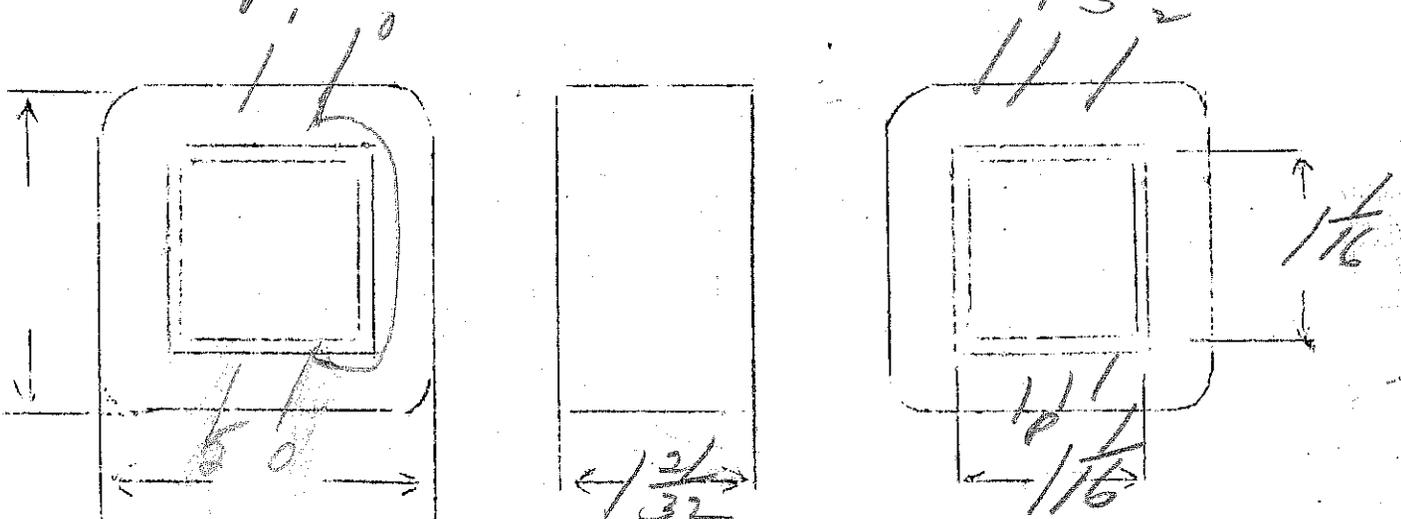

0 60
3 90
0
0 150

PO 0
25 500
30
PO 1981 0

2 to 2000 r

SPEC. NO. 1982

Winding	PRI	SEC					
Turns	1000	8					
Taps	—						
Wind. Lgth.	5/8"						
Wire Size	#33	#15					
T.P.L.	72-14						
Kind Term.	SIL BR	WIPE ONLY					
Term. Lgth.	3"	3"					
Layer Insul.	20#						
Wrapper	2L0056A	2L0056A					
TUBE	4L007		IMPREGNATION		VARNISH		
CURE	1/2 x 1/2						

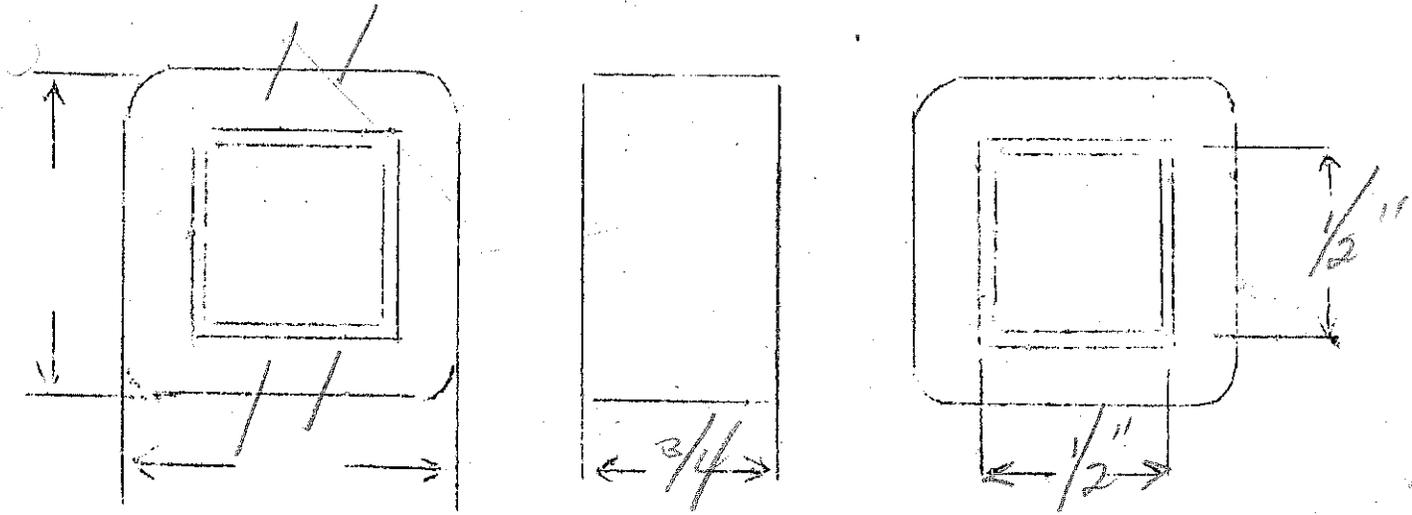

2 or to two 50 winding

SPEC. NO. 1983

Winding	PRI.	PR1	SEC				
Turns	145	145	8				
Taps							
Wind. Lgth.	5/8"	5/8"					
Wire Size	30	30	#15				
T.P.L.	50-3	50-3					
Kind Term.	Silver Braid	WIRE ONLY					
Term. Lgth.	3"	3"	3"				
Layer Insul.	30	30H	-				
Wrapper	1L005VP	2L005EA	2L005EA				
TUBE	4L007			IMPREGNATION	VARNISH		
CURE	1/2 x 1/2 29 @ 2x2						

no panel

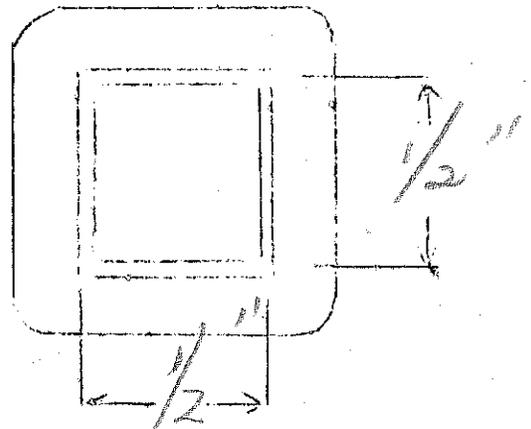
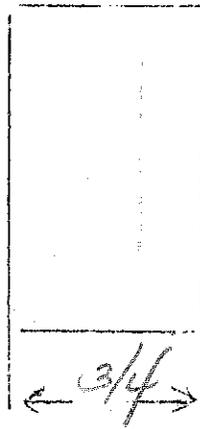
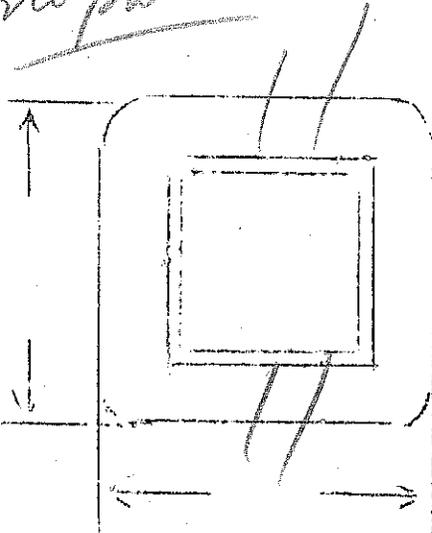

2 to 2000

SPEC. NO. 1984

Winding	PRI	SEC				
Turns	1000	8				
Taps	—	—				
Wind. Lgth.	5/8	—				
Wire Size	33	#22 Par Br.				
T.P.L.	72-14	—				
Kind Term.	Sil Br	same				
Term. Lgth.	3'	3"				
Layer Insul.	20#	—				
Wrapper	260056A	260056A				
TUBE	46007		IMPREGNATION		VARNISH	
CURE	1/2 x 1/2	29 1/2	2 x 2			

no panel

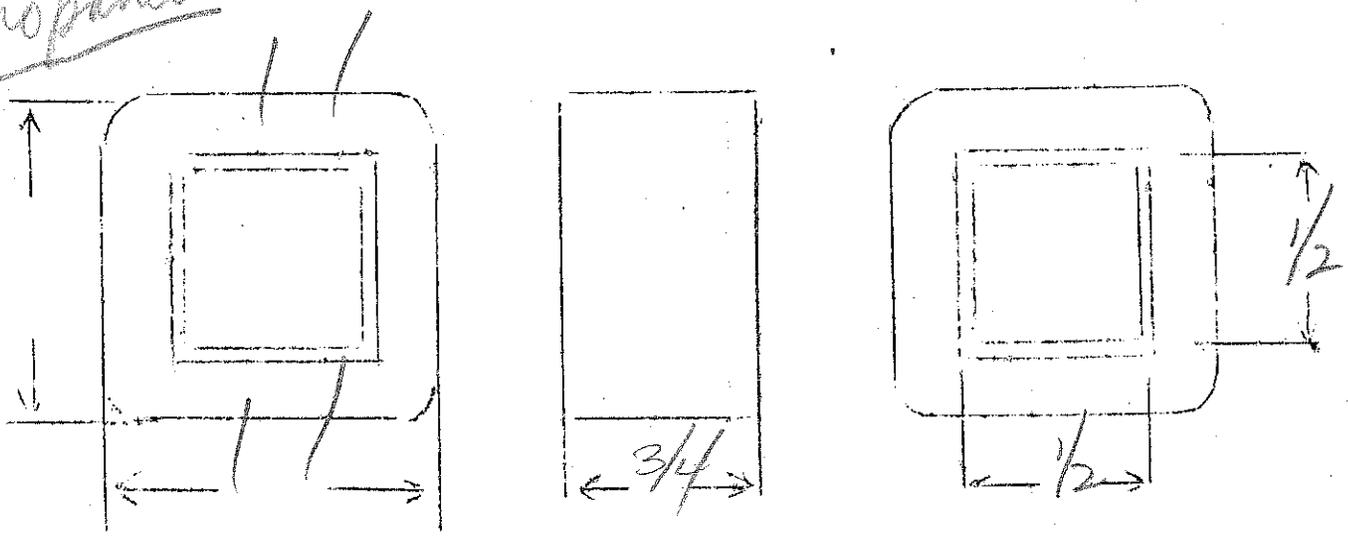

2. to two 50 or winding

SPEC. NO. 1985

Winding	P ₁	P ₁	Sec			
Turns	145	145	8			
Taps	—	—	—			
Wind. Lgth.	5/8	5/8				
Wire Size	30	30	#22 P.M. Braid			
T.P.L.	50-3	50-3	—			
Kind Term.	silver Braid	silver Braid	same			
Term. Lgth.	3"	3"	3"			
Layer Insul.	30#	30#	—			
Wrapper	11005VP	210056A	210056A			
TUBE	42007		IMPREGNATION	VARNISH		
CURE	1/2 x 1/2 - 21 1/2 x 2					

no panel

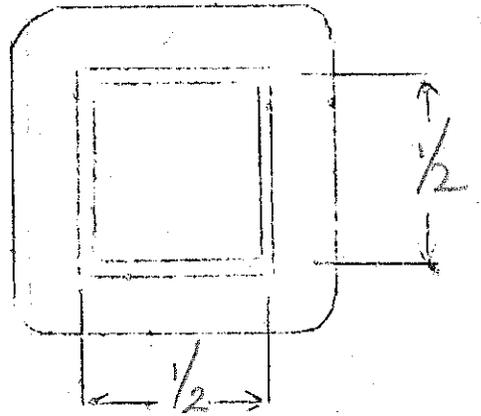
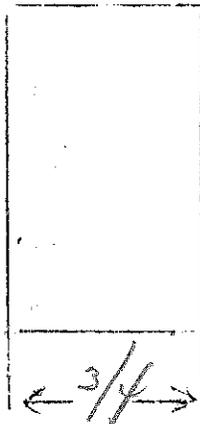
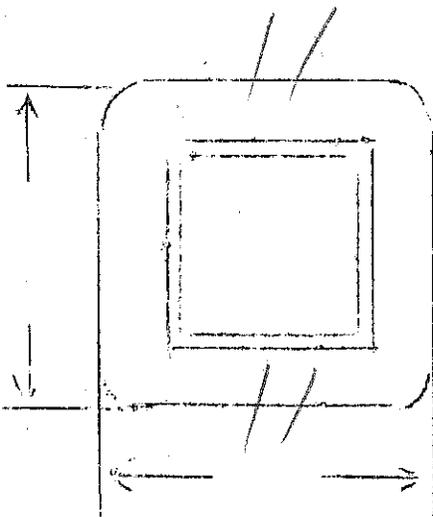

PPC5 to PP AB 646

3-1 step down ratio

SPEC. NO. 1986

Winding	SEC	PR1				
Turns	2680	8000				
Taps	1340	4000				
Wind. Lgth.	1.25	1.25				
Wire Size	#37	#38				
T.P.L.	225-12	252-32				
Kind Term.	SL #20 CR 07 PA	SL #20 CR 07 PA				
Term. Lgth.	3 in 9'	3 in 9'				
Layer Insul.	20#	20#				
Wrapper	14007K 46 26	26005GA				
TUBE	72007		IMPREGNATION	VARNISH		
CURE	1x 7/8	29.5	B Grad	2x2		

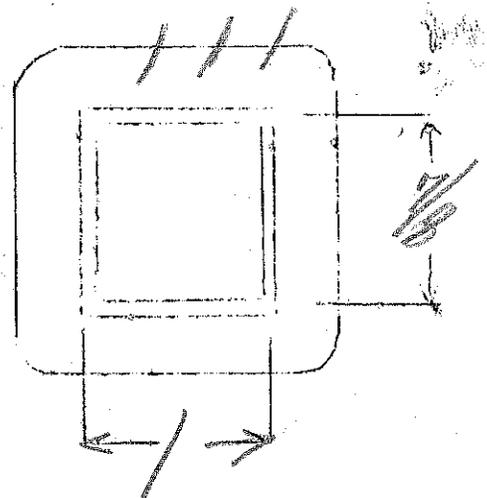
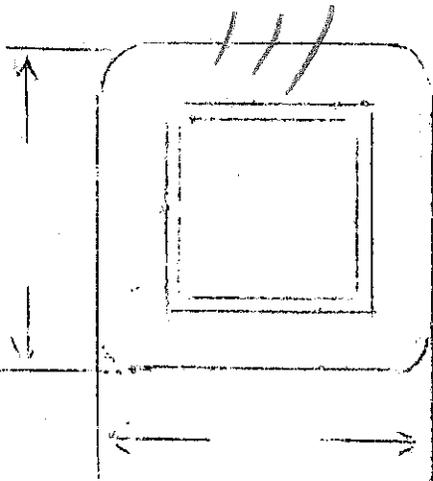

OK

Audio-Driver
 Class AB Interstage
 Ratio 2.5 to 1 (Down)
 (One Watt Primary)

SPEC. NO. S-1988

Winding	Sec. 1	Pri.	Sec. 2	
Turns	1330	6620	1330	
Taps	-	3310	-	
Wind. Lgth.	1-1/16"	1-1/16"	1-1/16" = 1.06"	
Wire Size	#37	#37	#37	
T. P. L.	195 - 7L	195 - 34L	195 - 7L	
Finish Pitch	88%	90%	88%	
Type Lead	#22 Pr. Br.	#22 Pr. Br.	#22 Pr. Br.	
Lead Lgth.	9"	9"	9"	
Layer Insul.	1L 20#G	1L 20#G	1L 20#G	
Test Volt.				
Wrapper	1L .005" VC 4L - 20#G	1L .005" VC 4L - 20#G	2L .005" GA	

TUBE 7L - .007" GK IMPREGNATION VARNISH

CORE 7/8" x 1" E & I GA. 29 GRADE D - Annealed STACK 1 x 1

MOUNTING "A" - Leads Only.

Wire Net = 0.294" (0.284")
 Cu = 1980 @ 10 Ma.

6620 = 27.6
 280

Fe = 42.4 @ 25 Cycle

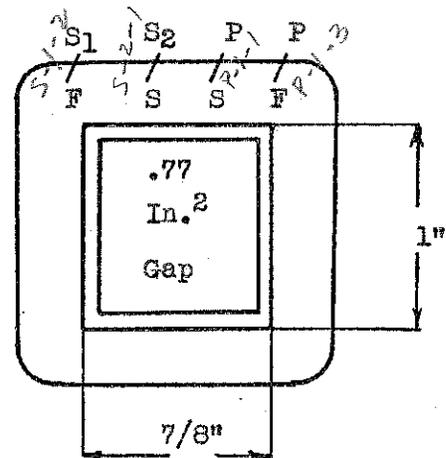
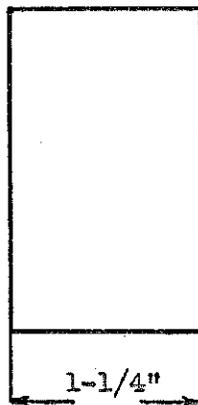
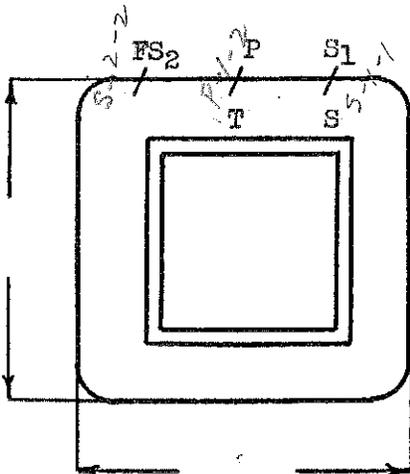

Re-DESIGNED BY H. W. S.

DATE 8 - 1 - 41

35
 (20)

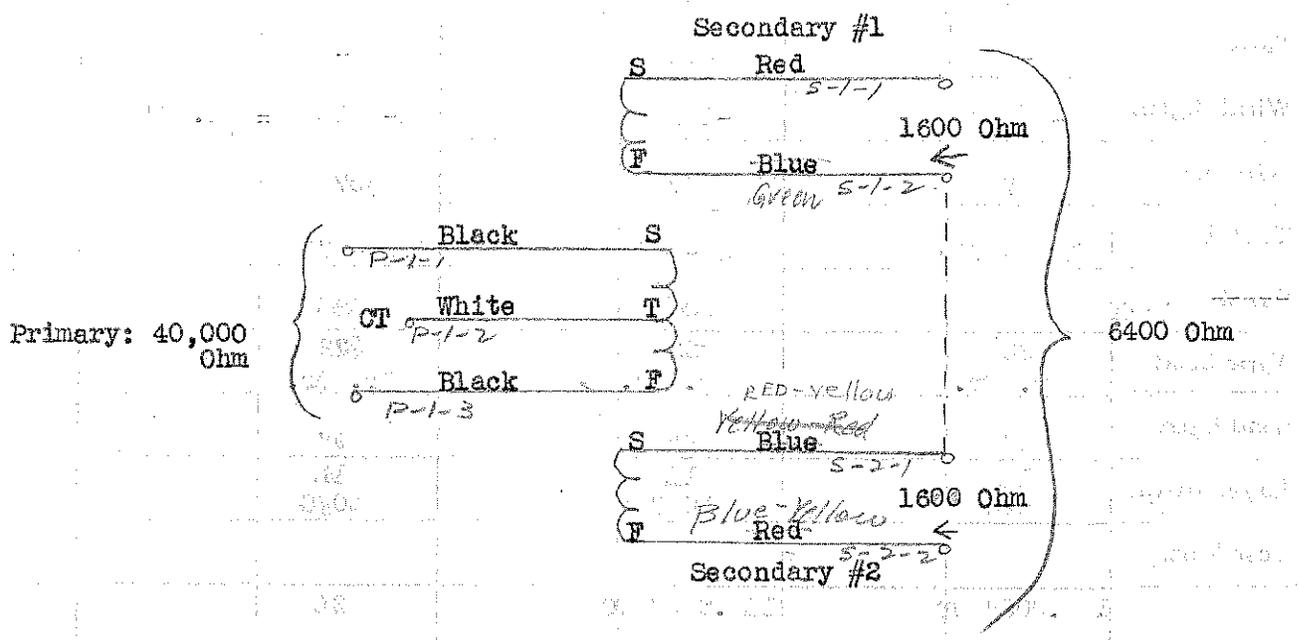

Z = 40,000 - 6,400 - 1,600

Z_R = 25 - 4 - 1

T_R = 5 - 2 - 1

T = 6,500 - 2,600 - 1,300

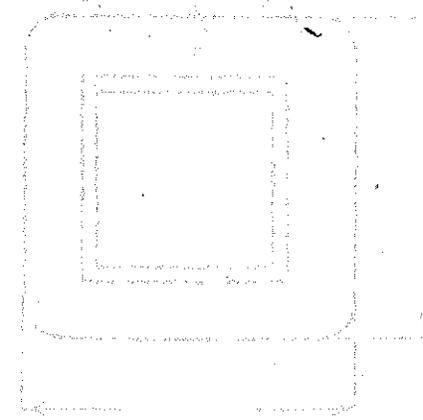
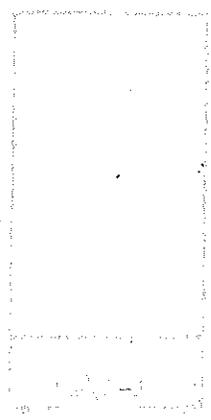
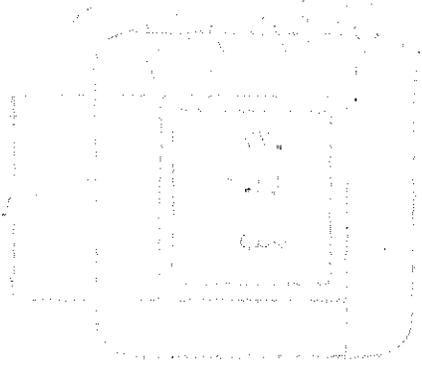

PP6L6 AB (4000 Ω) to 3500 Ω @ 300 ma
 5000 Ω @ 200 ma 7500 V Ins
 7500 Ω @ 150 ma on sec
 10,000 Ω @ 100 ma

SPEC. NO. 1989

MODULATION

Continuous

Winding	PR1	SEC				
Turns	2000	1900	870	450		
Taps	1000		500			
Wind. Lgth.	1 9/16	1 9/16				
Wire Size	#31	#28	#30	#33		
T.P.L.	145-14	110-18	130-7	190-3		
Kind Term.	WIRE ONLY		✓	✓		
Term. Lgth.	3"	3"	3"			
Layer Insul.	double 16#	double 16#	✓	✓		
Wrapper	3100 VC				3100 VC 3100 TEA	
TUBE	7L007+1L00 VC		IMPREGNATION		VARNISH	
CURE	1 1/4 x 2 1/2 Dynema Grade gap .020"					

heavy insulation!

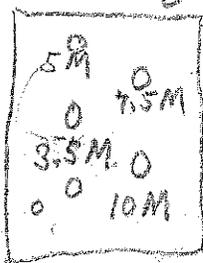
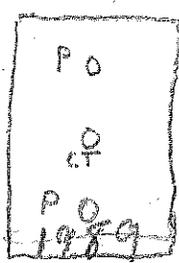
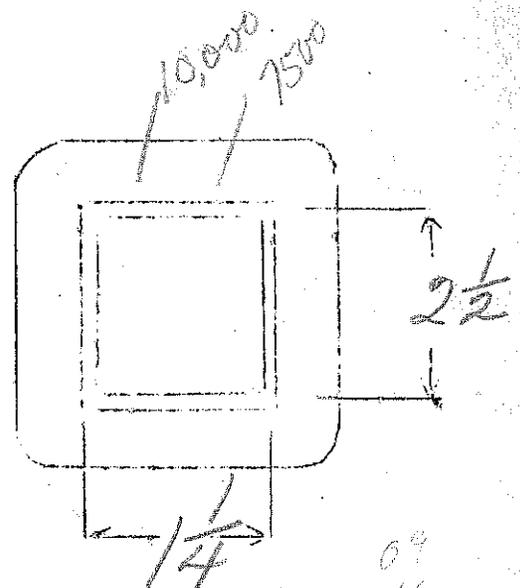
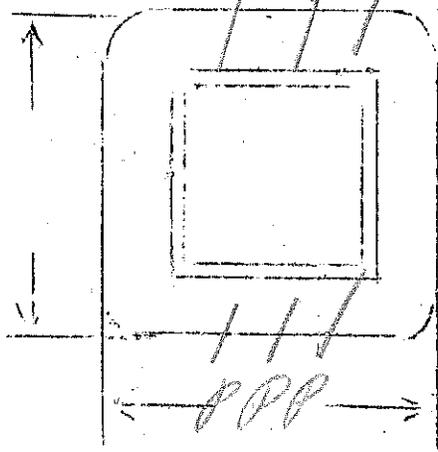

09
16
06
2
8
6
2
32

single 6L6 to 3-6-9-15 500Ω output // Watts max
 (4500 Ω pri)

SPEC. NO. 1990

Continuous

Winding	PRI	SEC			
Turns	2240	867	68	33	82
Taps	—	—	42		
Wind. Lgth.	1/25	—	—	—	—
Wire Size	#34	#31	#24	#22	#21
T.P.L.	1/2 7/4	1/5-8	—	—	—
Kind Term.		silver Br.		WIRES ONLY	
Term. Lgth.	3"	3"	3"	3"	3"
Layer Insul.	30#	30#	50#		
Wrapper	1L007VC	1L005GA			2L005GA
TUBE	1L007		IMPREGNATION		VARNISH
CURE	1x/8	299	Black audio		.010" gap

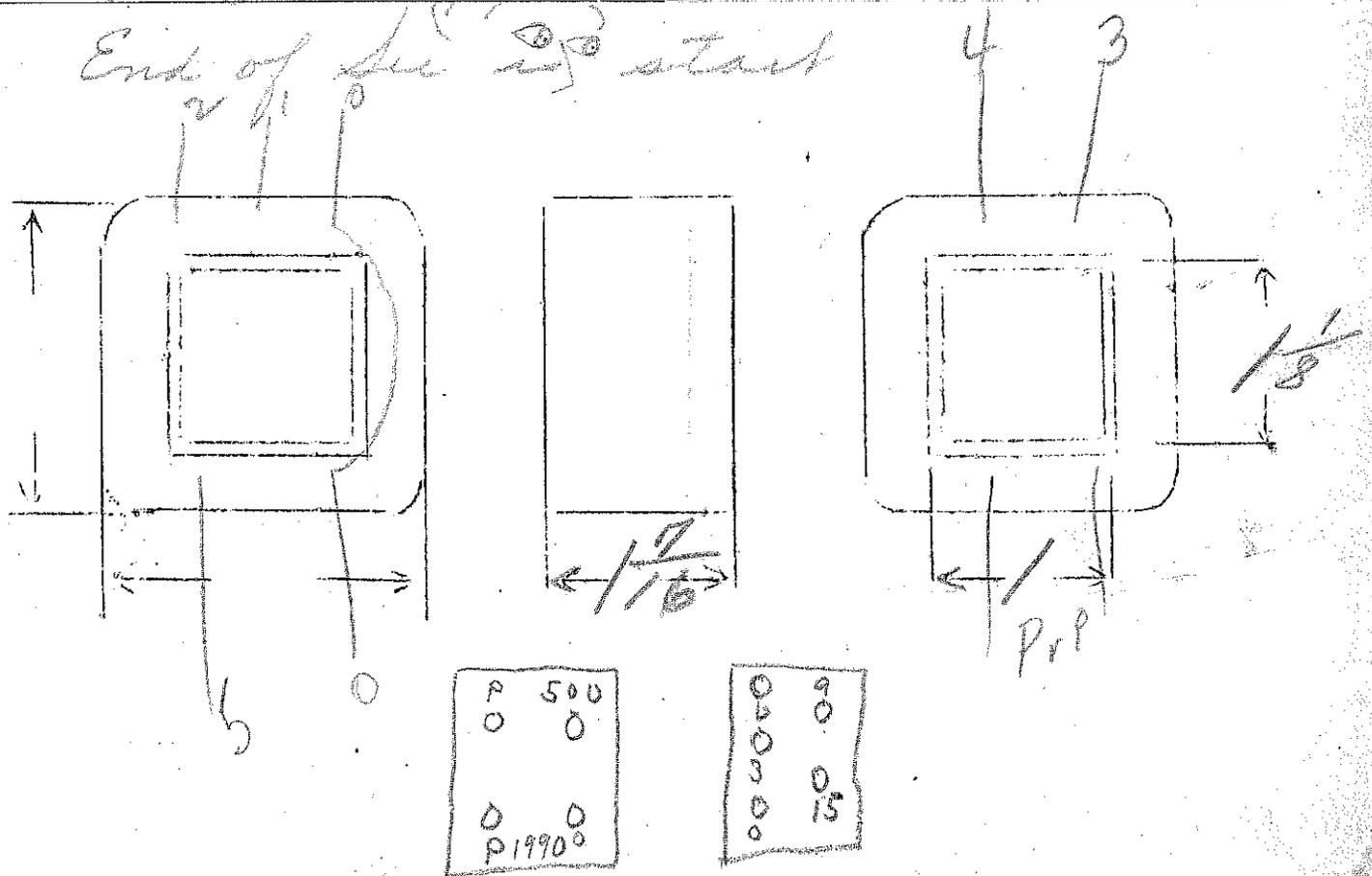

PP6C502 Angle 6N R Connected to PPAB 626
 (6AB) (high fidelity)
 2.75-1 Step down SPEC. NO. 1991

Winding	SEC	SHIELD	PR1			
Turns	1400	1	3850			
Taps	—		—			
Wind. Lgth.	1/2"	1/2"	1/2"			
Wire Size	#35	Shim stick	#38			
T.P.L.	72-20		108-38			
Kind Term.	Sil Pr	Sil Pr	Sil Pr			
Term. Lgth.	9"	3"	9"			
Layer Insul.	20#		20#			
Wrapper	210077C 31 48.2	110077C 31 20	210056A			
TUBE	71007	IMPREGNATION		VARNISH		
CURE	1X 7/8	29.50 'A' Grade annealed 292				

finish primary coils together
 bring all secondary leads out

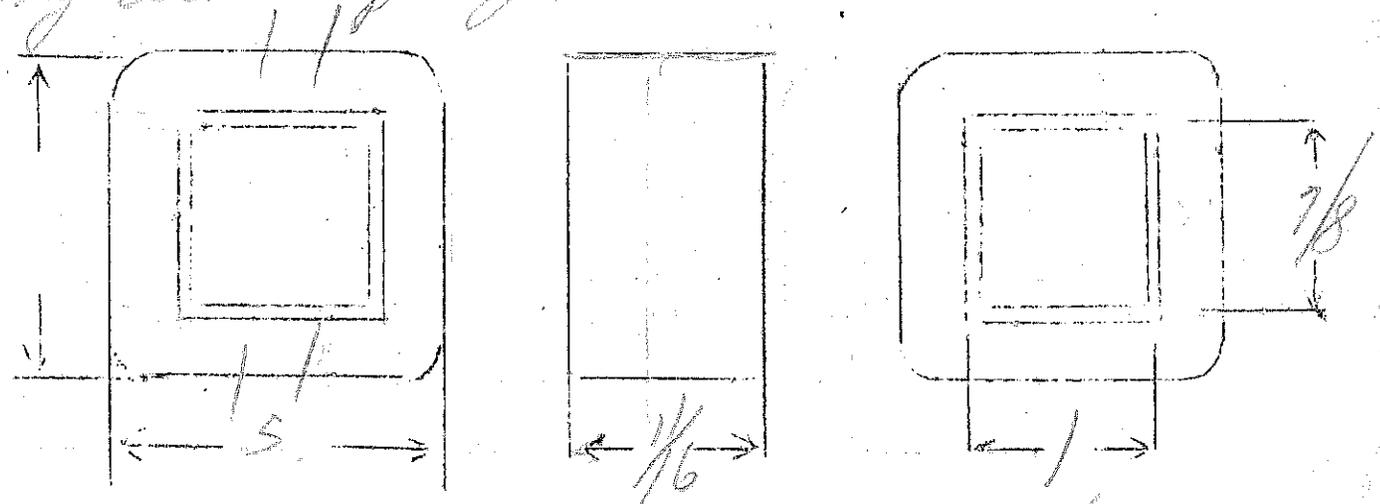

Reverse assembly

11

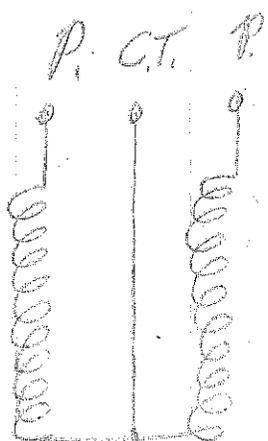

Reverse Assembly

SHIELD

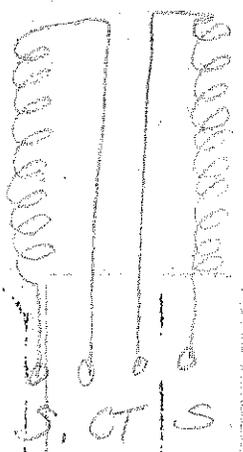

outside red
inside blue

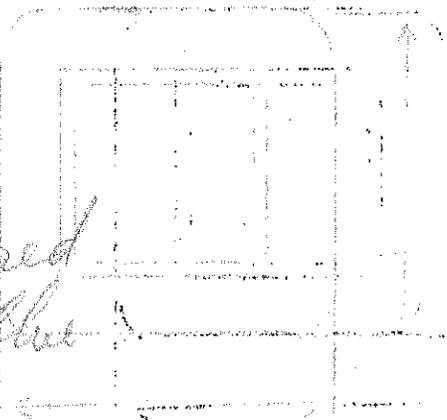

500 Ω to 700 Ω

SPEC. NO. 1992

Winding	PRI	SEC				
Turns	860	1000				
Taps	—	—				
Wind. Lgth.	15/16	15/16				
Wire Size	31	31				
T.P.L.	86	86				
Kind Term.	Fil Enam					
Term. Lgth.	3"	3"				
Layer Insul.	30#	30#				
Wrapper	1007K	210056A				
TUBE	4007		IMPREGNATION		vac	
CURE	3/4 x 3/4 rods connected 2x2					

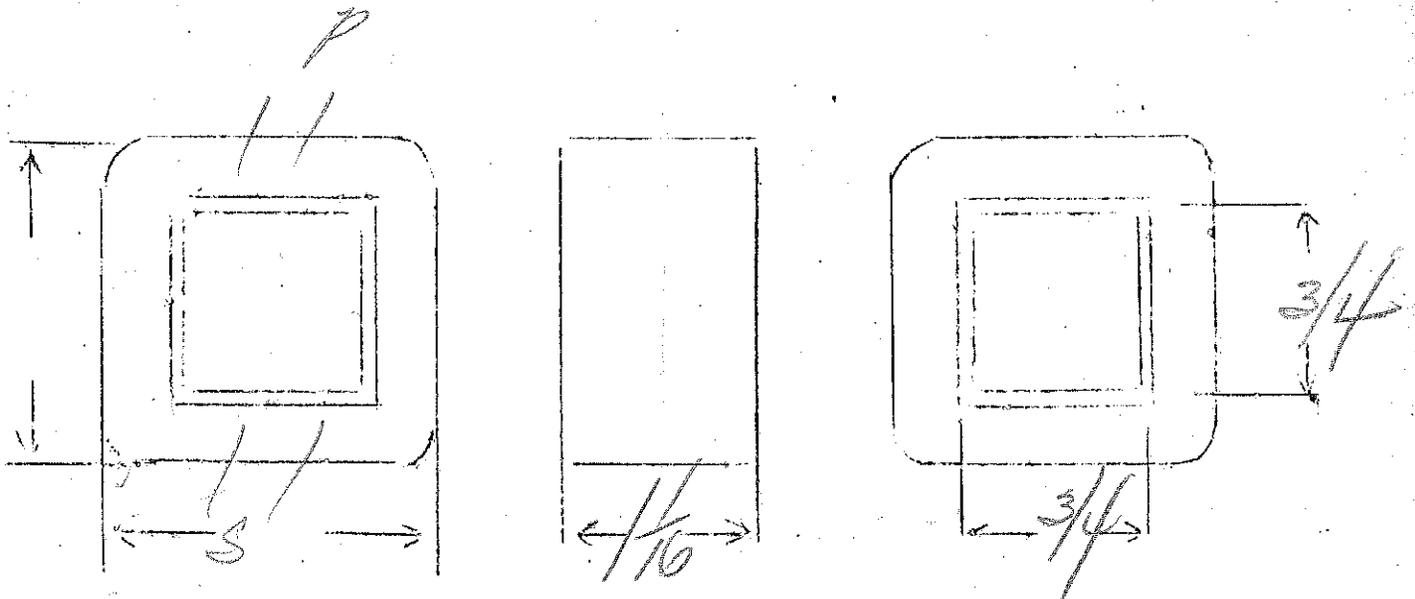

PP Parallel 48 to 15-3.5-5-75-15- Ω
 1500 Ω P-P
 Pri 110ma.

SPEC. NO. 1993

Continued

Winding	PRI	SEC					
Turns	1326	42	48	42			
Taps	663		3522				
Wind. Lgth.	$\frac{1}{16}$	—	—	—			
Wire Size	#32	#20	#22	#24			
T.P.L.	11-12						
Kind Term.	5/8 Br.	WIPE ONLY					
Term. Lgth.	3"	3"	3"	3"			
Layer Insul.	30#						
Wrapper	210056A			210056A			
TUBE	76007			IMPREGNATION	VARNISH		
CURE	$\frac{7}{8} \times \frac{7}{8}$			2X2			

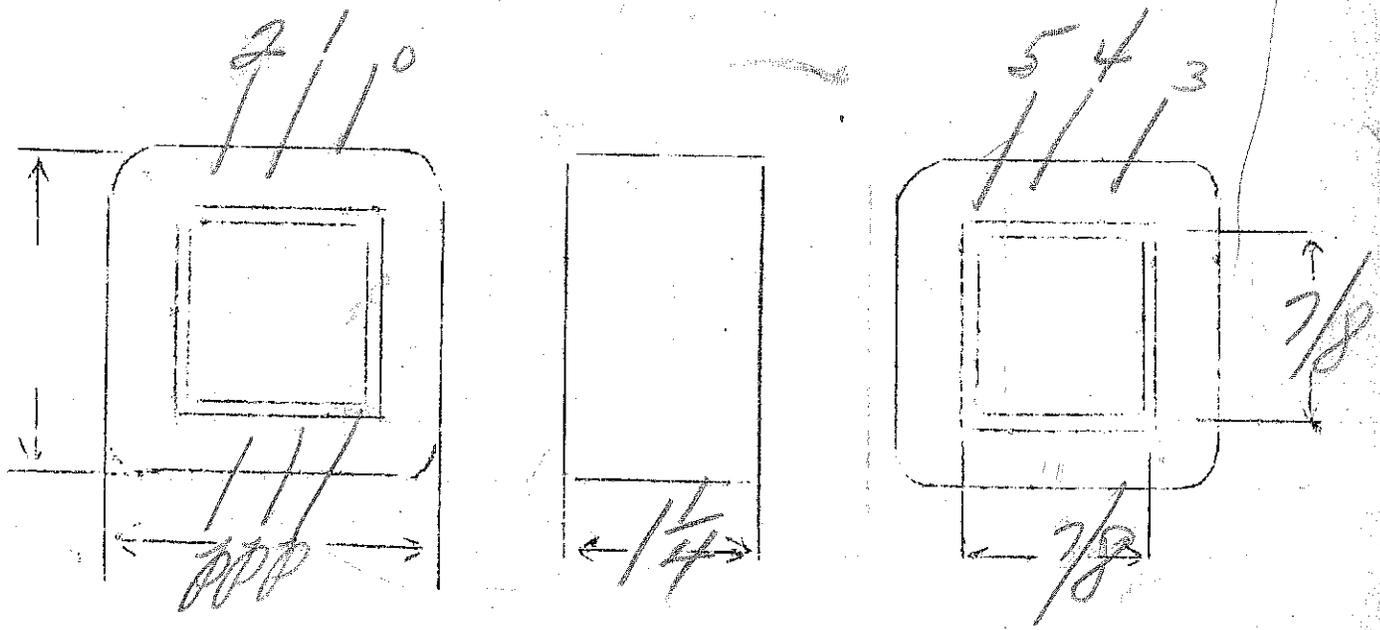

PP, Class AB 6L6 to Class C - 2500Ω - 250Ma. } 5000V
 5000Ω - 200Ma. } Insulation
 7500Ω - 150Ma. }
 60 Watt

011

SPEC. NO. S1995

Winding	Pri	Sec	- Continuous -			
Turns	1700	1360	570	420		
Taps	8/50					
Wind. Lgth.	1 5/8"	1 1/2"	1 1/2"	1 1/2"		
Wire Size	#29	#27	#29	#31		Mica Saddle
T. P. L.	123-14	91-15	114-5	140-3		
Finish						
Type Lead	(White B/y.)		- Sil. Br. -			
Lead Lgth.	6"	6"	6"	6"		
Layer Insul.	double 16#	double 16#	double 16#	double 16#		
Test Volt.		5000V				
Wrapper	3L007VC			2L007VC 2L007GA		

TUBE 7L007GK + 1L007VC IMPREGNATION Varnish

CORE 1 1/4 X 2 1/4 GA. 24 GRADE D STACK 0.02" gap

MOUNTING F

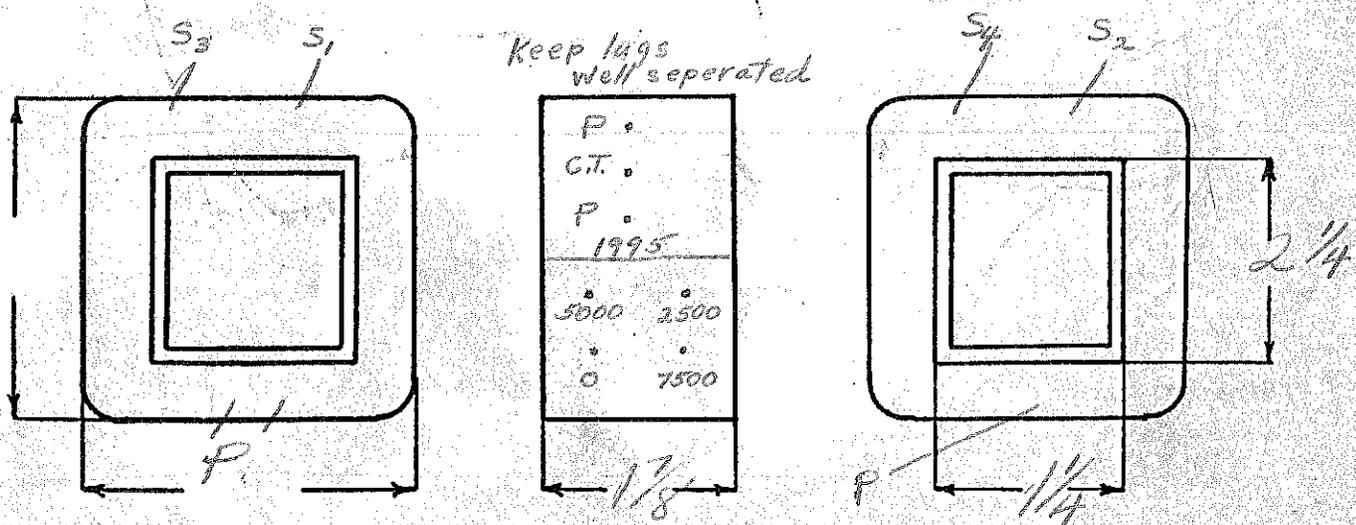

DESIGNED BY G.W.3

DATE

MODULATION

STOCK

PP Class AB 6L6's 3800 ohms CT
 to 3500 ohms @ 225 Ma. D.C.
 or 5000 ohms @ 200 Ma. D.C. 60 watts
 or 8000 ohms @ 150 Ma. D.C.

SPEC. NO. S-1995-FF

Winding	1-2-3 Pri.	4-5 Sec #1	6-7-8 Sec #2
Turns	1400	1290	660
Taps	700	--	250
Wind. Lgth.	1 3/4	1 1/2	1 1/2
Wire Size	#28	#28	#30
T. P. L.	117-12L	100-13L	125-6L
Finish	91%	91%	90%
Type Lead	Silver Braid Vinyl Sl.	Silver Braid Vinyl Sl.	Silver Braid Vinyl Sl.
Lead Lgth.	6"	6"	6"
Layer Insul.	40#	30#	30#
Test Volt.	2500	5000	5000
Wrapper	.187 2L007VG 3L40# Interleaved	.197 1L30#	.074 2L007VC 2L007GA

TUBE 10L007GK plus 2L003VB IMPREGNATION Varnish

CORE 1 3/8 x 2 1/2 GA. 29 GRADE B STACK Butt .007 Gap

MOUNTING FF

F. P. V. -
 window - $.626 / .688 = 90.9\%$

3 2 1

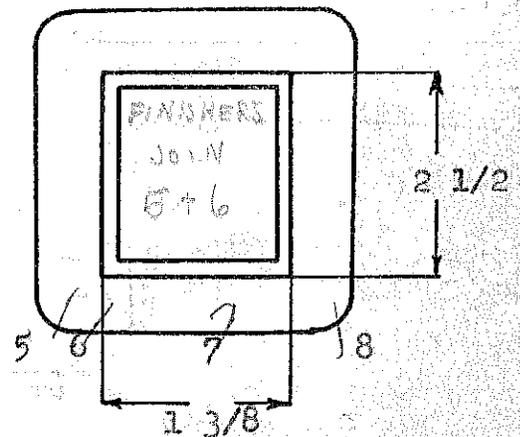
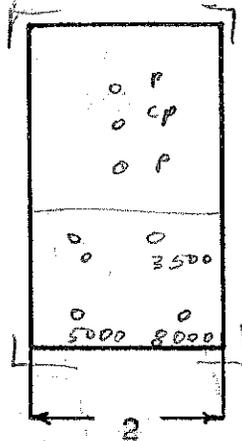
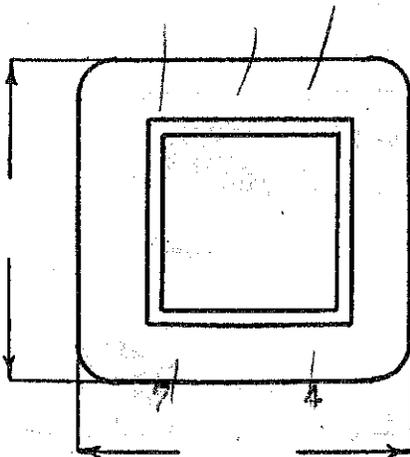

DESIGNED BY *Rearmitts*
 F.E.

DATE

DESIGN AND TEST DATA

Rating: Z = 3800 - 8000 - 5000 - 3500
 Zr = 1.086 - 2.29 - 1.428 - 110
 Tr = 1.042 - 1.513 - 1.195 - 1.00
 T = 1400 - 1950 - 1540 - 1290

Winding		Pri.		Sec #1	Sec #2		
Mean Turn		9.0		10.62	11.64		
Resistance 25° c		69.5		75.5	67.2		
Pounds Copper		.515		.561	.198		
Copper Density							
Ratio Volts		110 55		101	52 19.6		
Test to Ground		2500		5000			

Iron Induction @ _____ Cycles

Exciting Current _____ amperes @ _____ volts 60 cycles on

Induced Test: Apply _____ Volts at _____ Cycles on _____ with _____ grounded

Remarks:

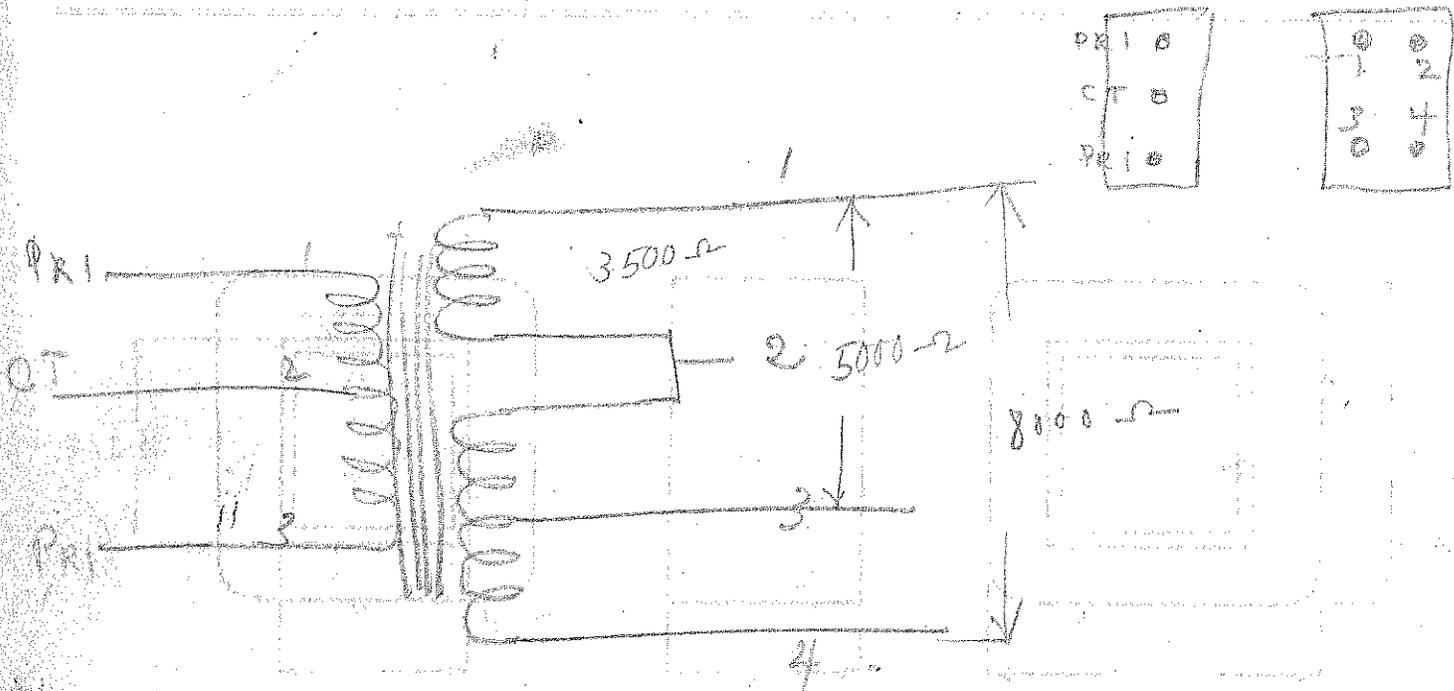

PPAB 6L6 (3800 or 6000) to
 1.5 - 3 - 6 - 9 - 15 - 500Ω
 30 watt capacity

SPEC. NO. 1996

Continuous

Winding	PR.1	SEC	4.34	2.09		
Turns	2500	625	46	22	56	
Taps	1250 250	594	26		16	
Wind. Lgth.	1.75	1.75	2.16		1.52	
Wire Size	#30	#28	#21	#19	#16	
T.P.L.	11140	115-6				
Kind Term.	sil Braid		WIRES ONLY			
Term. Lgth.	4"	4"	4"	4"		
Layer Insul.	40#	40#				
Wrapper	120076C	120076A			260076A	
TUBE	7007		IMPREGNATION		VARNISH	
CURE	1/4" x 1/4"	1/226.9a	1/229.9a	"F" MT6		

end of sec is start of sec impedances

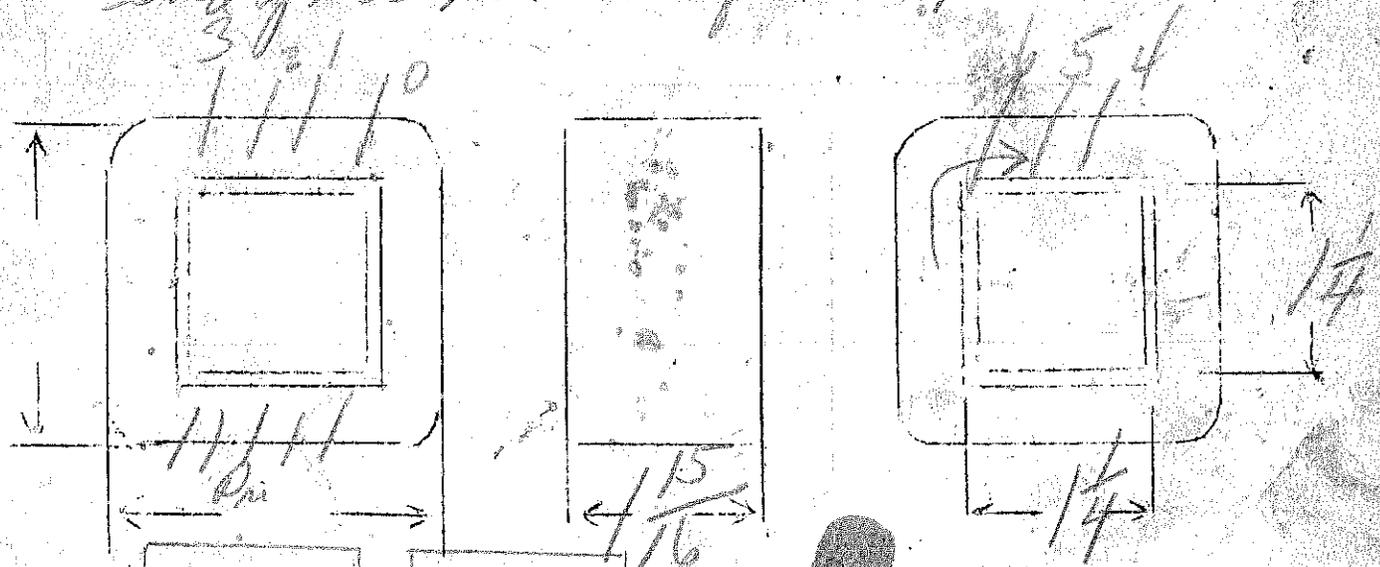

60 09
 30 015
 150
 0.0 0.500

6000
 0
 3800
 1996

59

pp 45 to PPAB 2A3

split secondary

P-25
bs

SPEC. NO. 1997

Winding	SEC	PRI				
Turns	1130	1420				
Taps						
Wind. Lgth.	1/2"	1/2"				
Wire Size	33	34				
T.P.L.	59-20	-22				
Kind Term.	sil	Braid				
Term. Lgth.	4"	4"				
Layer Insul.	30#	30#				
Wrapper	1100710	220056A				
TUBE	72007		IMPREGNATION		WAX	
CURE	1X1		24h annealed		- 2x2	

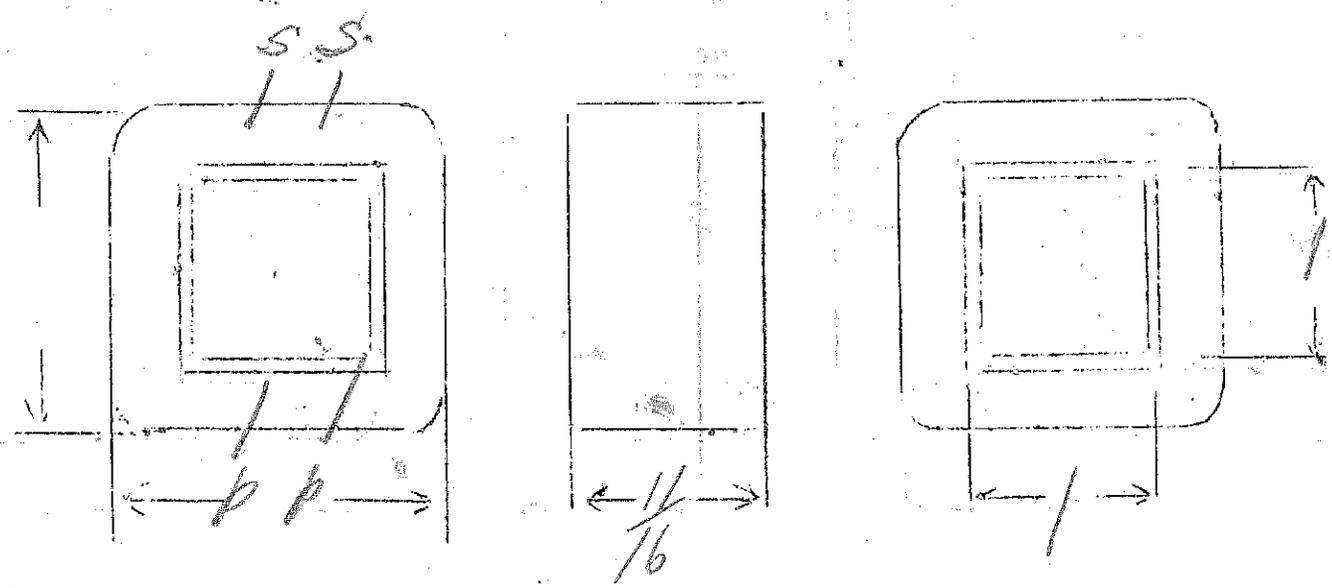

Reverse assembly

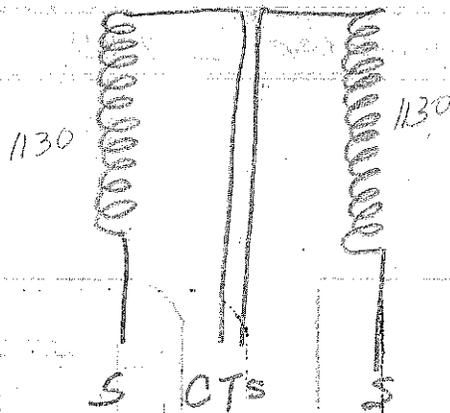
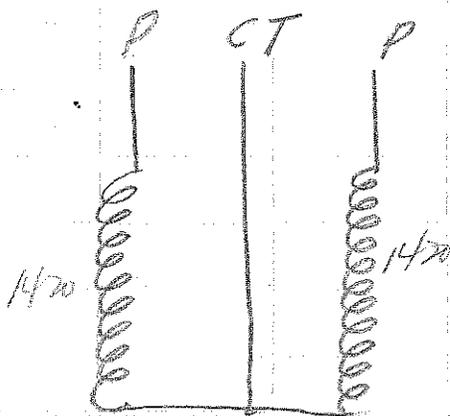

see leads out



PPAB2A3 to 3-6-9-15-500 Ω
 3000 +34 DB - HC MFG

650

SPEC. NO.

1998

Continuous

Winding	P ₁	P ₂	SEC			
Turns	800	800	1060	50	72	100
Taps					32	
Wind. Lgth.	5/16	5/16	13/16			
Wire Size	#32	32	#29	#22	#21	#19
T.P.L.	32-25	32-25	63-19	28-7	25-3	20-5
Kind Term.	Sil bond		WIPE ONLY			
Term. Lgth.	4"	4"	4"	4"	4"	4"
Layer Insul.	30#	30#	30#	.005		
Wrapper	2L005VP	2L005GA				2L005GA
TUBE	7L007		IMPREGNATION		VARNISH	
CURE	1/4 x 1/4		- 29% Annealed 2x2			

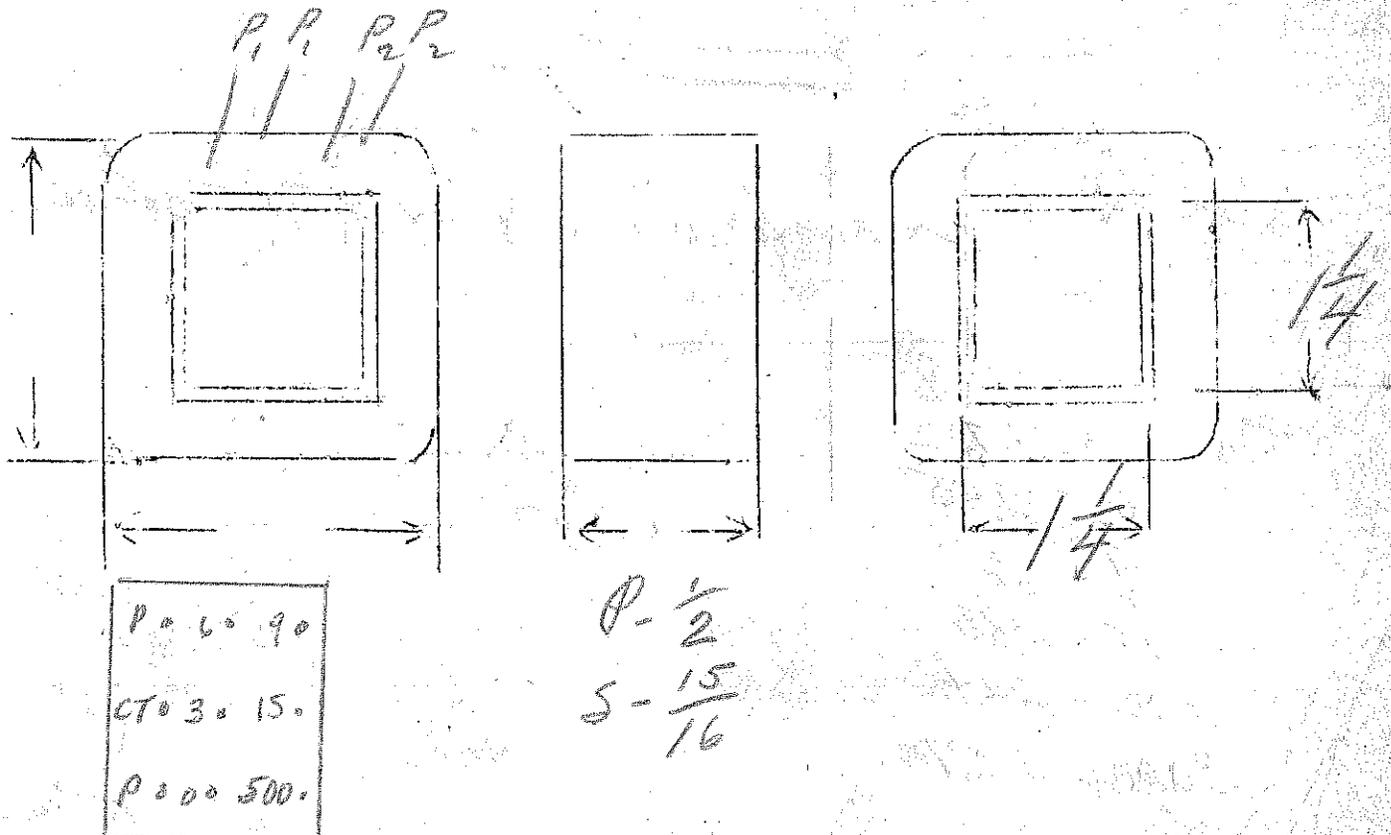

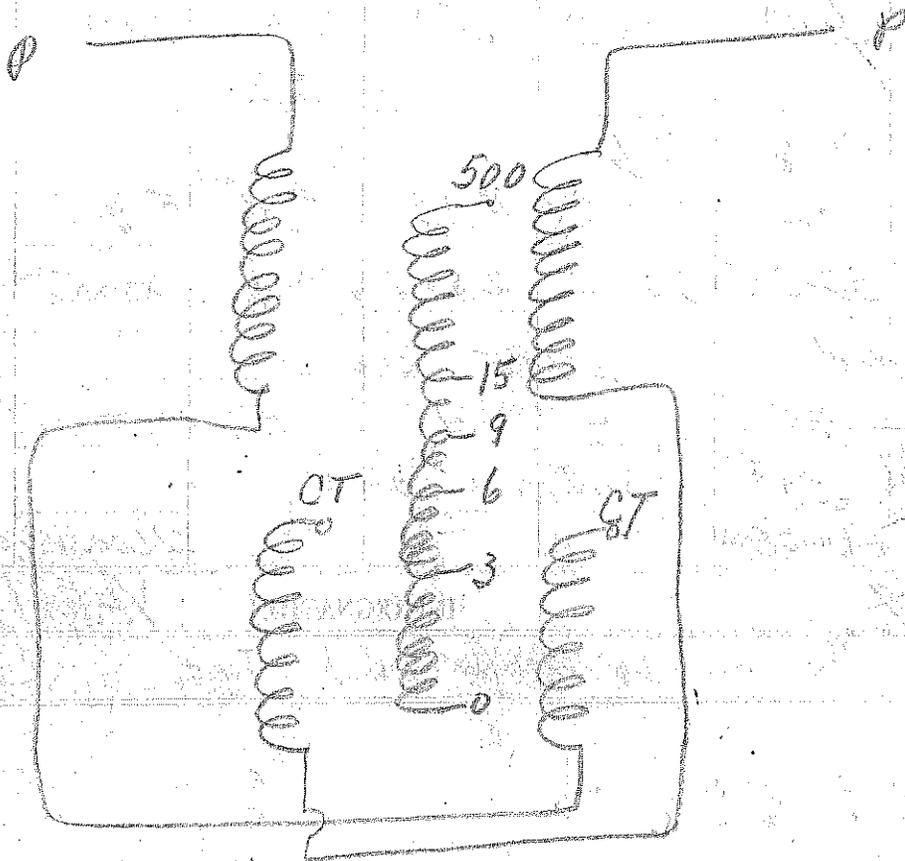

end of winding is start of sec.

- 3 - 1.732
- 6 - 2.45
- 9 - 3
- 15 - 3.88
- 500 - 22.4
- 3000 - 54.7